

# CIRANDA DAS

Sí-la-bas

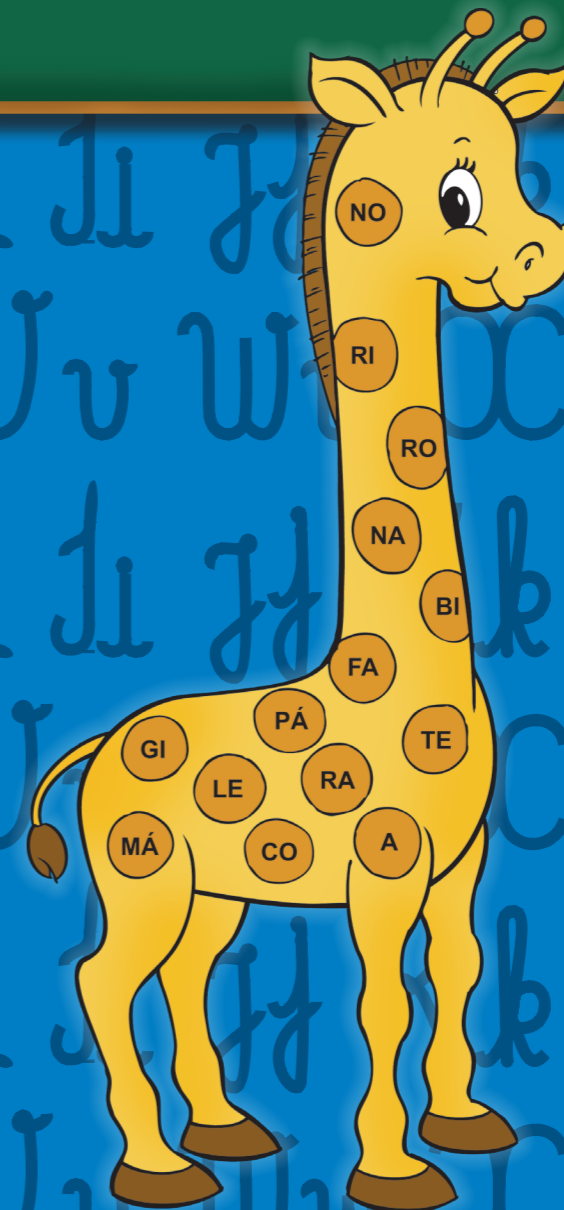

A coleção “CIRANDA DAS SÍLABAS” é composta por seis volumes, organizados em lições que apresentam atividades seqüenciais. Nos volumes 1 e 2, as lições envolvem o trabalho com vogais e consoantes, facilitando o aprendizado do alfabeto. Os demais volumes estão voltados à sistematização das famílias silábicas, permitindo, dessa maneira, que o professor avalie sistematicamente os avanços de seus alunos, fazendo intervenções adequadas ao perceber que algum aluno não está aprendendo de forma satisfatória.

  
Ruth Rozendo Caputo

ISBN 978853800010-5



9 788538 000105



Ciranda Cultural  
[www.cirandacultural.com.br](http://www.cirandacultural.com.br)



Ciranda Cultural

Volume 5

a q u b A C S Z m X N O P C G V  
p  
c  
v  
o  
g  
s  
a  
s  
u  
D  
q  
N  
G  
ç  
h  
C b v H a B q A C u z m O X

### PARLENDIA

O DOCE PERGUNTOU PRO DOCE  
QUAL É O DOCE MAIS DOCE?  
E O DOCE RESPONDEU PRO DOCE  
QUE O DOCE MAIS DOCE  
É O DOCE DE BATATA-DOCE.

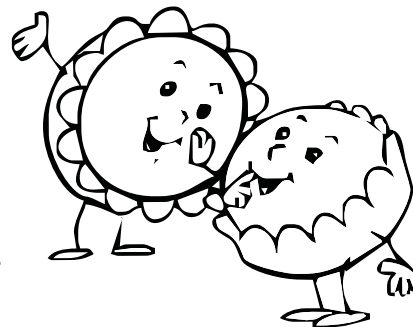

DOMÍNIO PÚBLICO

ASSINALE NO TEXTO, ACIMA, A PALAVRA DOCE.

DOCE

doce

CE - C

ce - c

SEPARE A PALAVRA DOCE EM LETRAS E SÍLABAS.

DOCE

VEJA O QUE PODEMOS ESCREVER COM A SÍLABA **CE**.  
CIRCULE CADA **CE** NAS PALAVRAS ABAIXO.

- |         |         |          |
|---------|---------|----------|
| CÉDULA  | DOCE    | CELA     |
| CEGO    | FACE    | CERA     |
| CEGONHA | VOCÊ    | CEBOLA   |
| CEDO    | BOCEJO  | CAPACETE |
| CENOURA | VICE    | CENA     |
| CEIA    | CEVADA  | CÁLICE   |
| CEREJA  | CÓCEGAS | CESTA    |

LIGUE E FORME PALAVRAS  
ESCREVENDO-AS AO LADO.

CE	GO	_____	CE	DO	_____
	DO	_____		FA	_____
	NOURA	_____		VO	_____
	BOLA	_____		VI	_____
	GONHA	_____			

BO	CE	JO
CAPA		TE
CÓ		GAS

NUMERE OS DESENHOS DE ACORDO COM AS PALAVRAS.

- |              |
|--------------|
| 1 - DOCE     |
| 2 - CENOURA  |
| 3 - CEBOLA   |
| 4 - CAPACETE |
| 5 - CÁLICE   |
| 6 - CÉU      |
| 7 - CEGONHA  |
| 8 - CESTA    |
| 9 - CEREJA   |



ADIVINHE:  
MINHA VIDA É UM PESADELO, JÁ NÃO SEI NEM O QUE FAÇO.  
POIS QUEM MAIS CHORA POR MIM, É QUEM ME CORTA EM PEDAÇOS?  
(CEBOLA)

JUNTE AS SÍLABAS ESCRITAS NA CENTOPÉIA, DE ACORDO COM OS NÚMEROS ABAIXO E ESCREVA AS PALAVRAS FORMADAS.

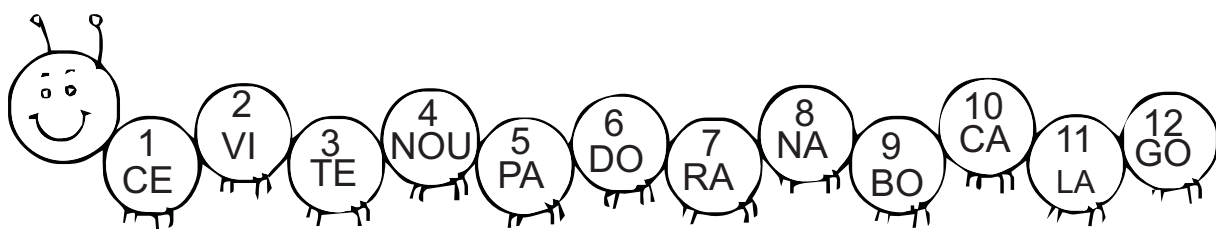

1 - 4 - 7	1 - 6	1 - 7	6 - 1
_____	_____	_____	_____
1 - 9 - 11	1 - 8	10 - 5 - 1 - 3	1 - 12
_____	_____	_____	_____
2 - 1	11 - 1	3 - 1	10 - 1
_____	_____	_____	_____

PINTE AS SÍLABAS, FORMANDO PALAVRAS. USE CORES DIFERENTES PARA CADA PALAVRA FORMADA.

CA	CE	CE	DO	_____	_____
BO	PA	NA	VO	_____	_____
CE	LA	CE	FA	_____	_____
LA	NOU	DO	CÊ	_____	_____
CE	TE	RA	CE	_____	_____
CE	CE	GO	CE	_____	_____

DESCUBRA O SEGREDO E ESCREVA OUTRAS PALAVRAS.

DOCE  
FACE  
VOCÊ

CÉU  
CESTA  
CEGO

CAPACETE  
CÓCEGAS  
CÁLICE

LIGUE O NOME AO DESENHO CORRESPONDENTE E ESCREVA A PALAVRA QUE VOCÊ LIGOU SEPARANDO-A EM SÍLABAS.

CEDO  
CEBOLA  
DOCE



CERA  
CENOURA  
CEBOLA

FACE  
VOCÊ  
DOCE

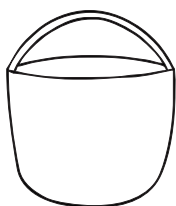

CESTA  
ACÉM  
VICE

CEVADA  
CÓCEGAS  
CAPACETE



CEGONHA  
CEGO  
CEIA



QUAL O NÚMERO DE SÍLABAS DAS PALAVRAS?  
ESCREVA NAS CEREJINHAS.

CENOURA



CEREJA



CÓCEGAS

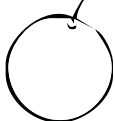

CEBOLA

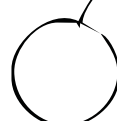

CEGO



CAPACETE



CEVADA



CEDO

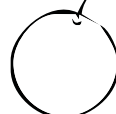

ESCREVA AS PALAVRAS NO DOMINOX,  
PORÉM SEPARANDO-AS EM SÍLABAS.

- CAPACETE
- CEDO
- BOCEJO
- CERVEJADA
- CEBOLA
- CERA
- CENOURA
- CENA
- DOCE
- CEGO

				CE
				GO

ESCREVA AS FRASES SUBSTITUINDO OS  
DESENHOS PELAS PALAVRAS CORRESPONDENTES.

CÉLIA FEZ SALADA DE ALFACE E  .

CELITA FEZ UM  DE  COM COCO.

NA  TEM  E  .

CÉLIO COLOCOU O  PARA ANDAR DE MOTO.

O BOMBOM FOI FEITO COM  .

CAÇA – PALAVRAS.

C	E	I	A	R	C	E	L	A	Q
Z	P	L	D	C	E	R	E	J	A
C	E	N	O	U	R	A	M	P	R
A	F	A	C	E	A	L	S	T	U
P	S	C	E	B	O	L	A	A	Z
A	C	E	G	O	N	H	A	C	P
C	É	R	Z	K	X	V	Q	É	C
E	U	T	W	D	F	C	E	M	E
T	V	O	Y	I	J	A	B	K	N
E	X	X	C	Á	L	I	C	E	A

DOCE	CEGONHA	CELA	CÉU
CÁLICE	FACE	CEREJA	CERTO
CENOURA	ACÉM	CEBOLA	CEM
CAPACETE	CEIA	CERA	CENA

a q u b A C S z m X N O p c G V

É HORA DO DITADO.

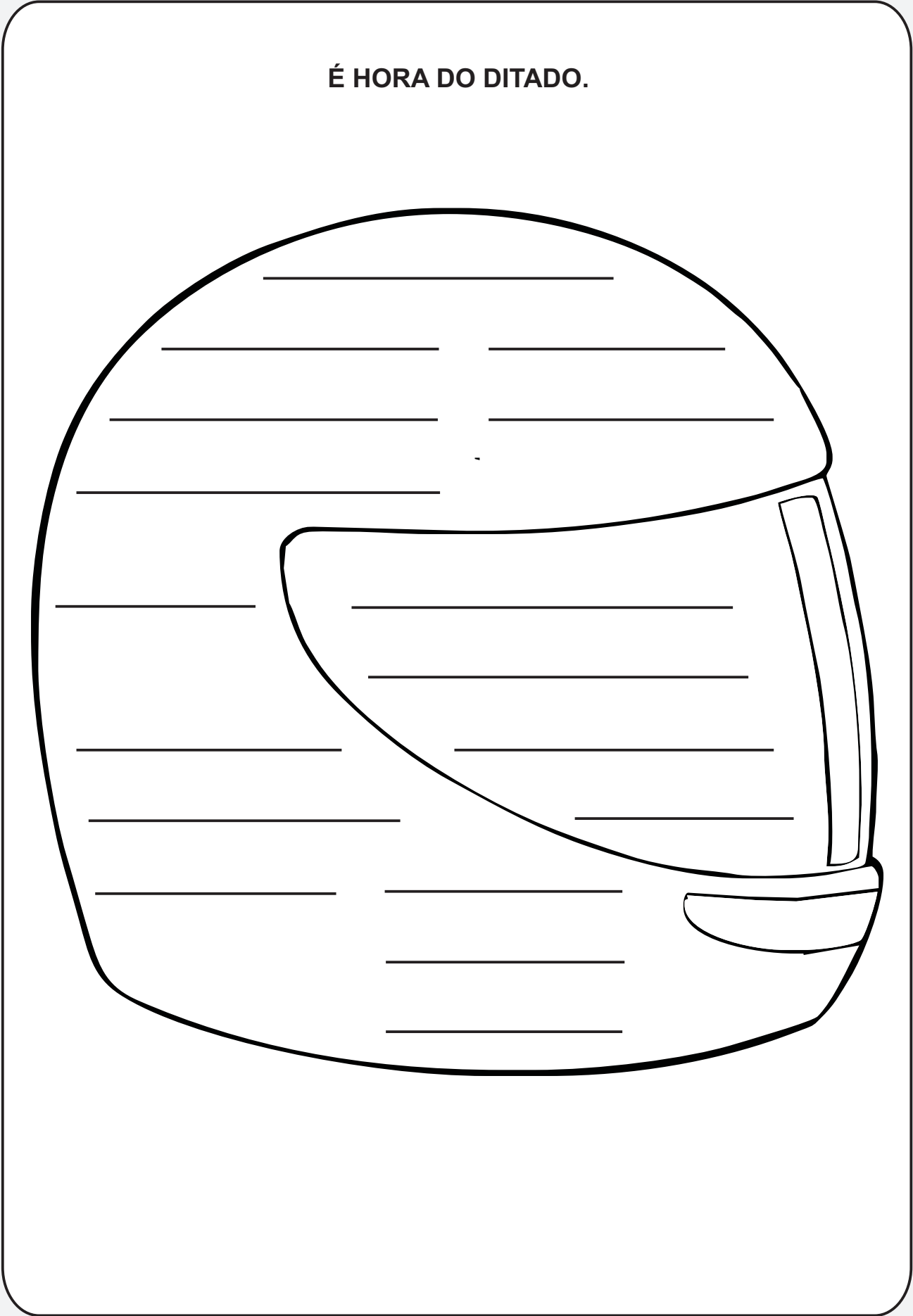

C b v H a B q A C u z m O X



## A CASINHA DA VOVÓ

A CASINHA DA VOVÓ  
TODA FEITA DE CIPÓ.  
O CAFÉ ESTÁ DEMORANDO  
COM CERTEZA FALTA PÓ.



(CD AS MELHORES CANTIGAS, CIRANDA CULTURAL, pág. 115.)

ASSINALE NO TEXTO DA CANTIGA, A PALAVRA **CIPÓ**.

COPIE.

**CIPÓ**

cipó

Ci-Ci

ci-ci

SEPARE A PALAVRA **CIPÓ** EM LETRAS E SÍLABAS.

CIPÓ

CIRCULE A SÍLABA **CI** NAS PALAVRAS DO QUADRO.

CINEMA	POLÍCIA	CICA	CIRCO
CIDADE	TECIDO	CINTA	MACIO
VACINA	FELICIDADE	BACIA	CECÍLIA
BICICLETA	SACI	APARECIDA	CACIQUE
CIGANA	VELOCIDADE	CIGARRA	CÍCERO

LEIA AS PALAVRAS ABAIXO E ESCREVA-AS,  
COMPLETANDO ADEQUADAMENTE AS FRASES.

PEIXE      CINEMA      SACI      CELA

O \_\_\_\_\_ PULA NUMA PERNA SÓ.

CERA      CEDO      POLÍCIA      OFICINA

CIDO TRABALHA NA \_\_\_\_\_ DE CARROS.

CEBOLA      VACINA      CENOURA      CÓCEGAS

O BEBÊ CHOROU PORQUE TOMOU \_\_\_\_\_.

CAPACETE      CESTA      TECIDO      CIGANA

MAMÃE FEZ UMA BLUSA DE \_\_\_\_\_ XADREZ.

CEREJA      CIDADE      CEBOLA      BACIA

CECÍLIA E APARECIDO FORAM PASSEAR NA \_\_\_\_\_.

JUNTE AS SÍLABAS E ESCREVA AS PALAVRAS FORMADAS.

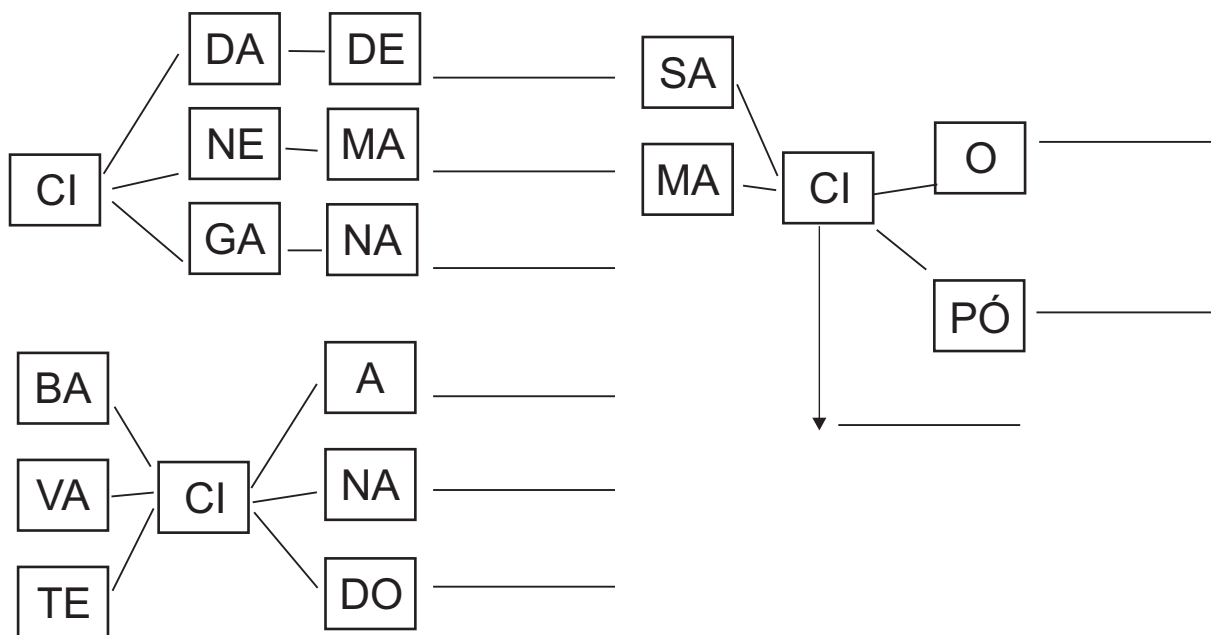

## CIRANDA, CIRANDINHA

CIRANDA, CIRANDINHA  
VAMOS TODOS CIRANDAR.  
VAMOS DAR A MEIA VOLTA,  
VOLTA E MEIA VAMOS DAR.

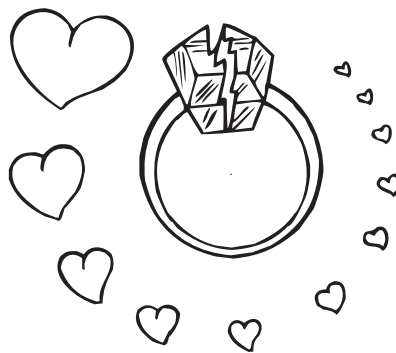

DOMÍNIO PÚBLICO

CIRCULE NO TEXTO DA CANTIGA,  
AS PALAVRAS QUE TÊM A SÍLABA **CI**.

PINTE AS SÍLABAS QUE CORRESPONDEM  
AOS NOMES DOS DESENHOS.



CI PE PÓ

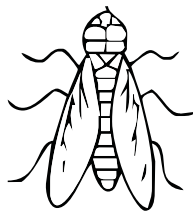

CI FA GAR RA



BA CA CI A



CA SA CE CI



DI CI GA MA NA















CIN SA TA SI























JUNTE AS SÍLABAS DO QUADRO E  
ESCREVA AS PALAVRAS FORMADAS.

+	DO	GA	NA	LA
CE	_____	_____	_____	_____
+	DA	PÓ	CA	DRA
CI	_____	_____	_____	_____

Substitua os símbolos pelas sílabas e forme palavras.

VA 	CE 	CI 	RA 	GO 	NA 
---	---	---	---	---	---

DA 	COI 	RE 	NHA 	NOU 	BO 
---	--	---	---	--	---

  	 	  
_____	_____	_____
 	  	 
_____	_____	_____
 	  	  
_____	_____	_____

Escreva abaixo o que se pede. Observe a sílaba solicitada.

SÍLABA	FRUTA	OBJETO	ANIMAL	NOME DE PESSOA
CE	_____	_____	_____	_____
CI	_____	_____	_____	_____

ADIVINHE:

Por fora sou verde e bem rajada, por dentro branca e vermelha. Todos gostam de me comer em fatias. Eu sou a \_\_\_\_\_.

(MELANCIA)

LEIA AS PALAVRAS E ESCREVA-AS NO QUADRO ABAIXO, DE ACORDO COM AS SÍLABAS INDICADAS.

CIDADE	CEGO	VACINA	DOCE
VOCÊ	CINEMA	CEBOLA	SACI
TECIDO	CENOURA	CIRCO	CAPACETE
CEDO	BACIA	CEIA	CIGANO

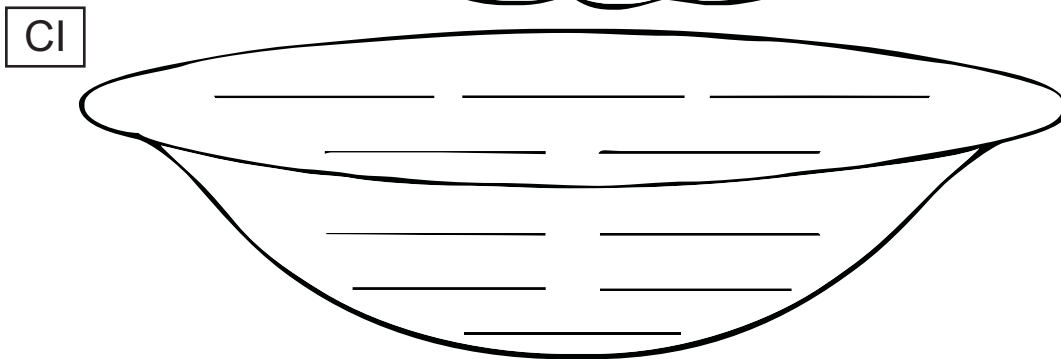
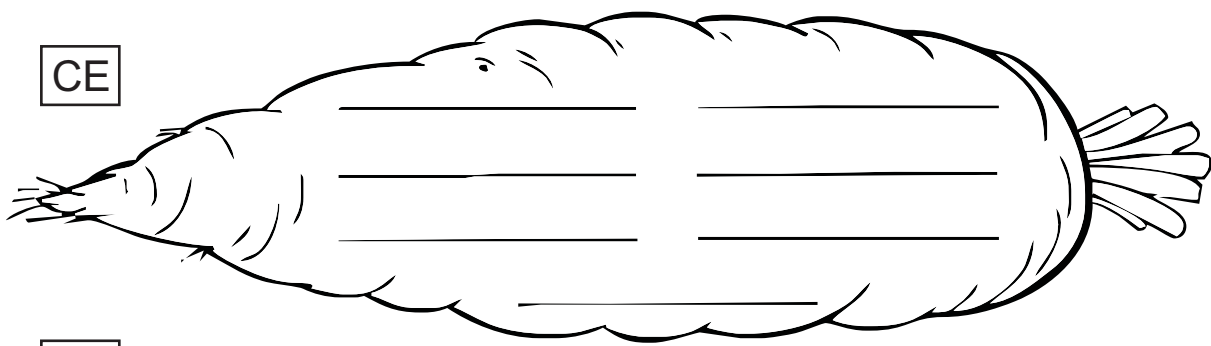

COMPLETE AS PALAVRAS COM AS SÍLABAS **CE** OU **CI**.  
DEPOIS ESCREVA, SEPARANDO-AS EM SÍLABAS.

___DADE

___DO

___GARRA

FELI___DADE

CAPA___TE

___BOLA

VA___NA

DO___

a q u b A C S Z m X N O P C G V

CRUZA - PALAVRAS.

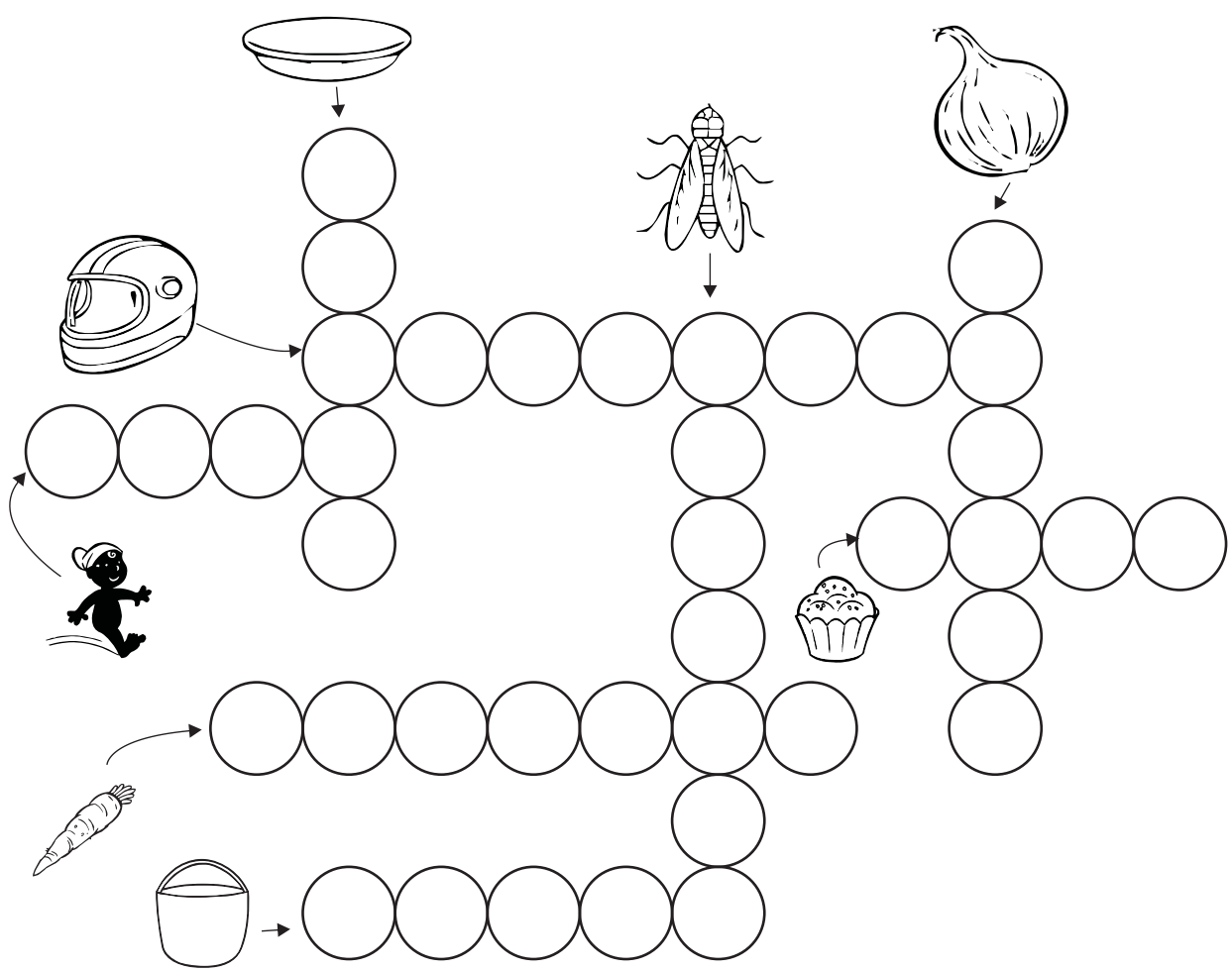

CESTA	DOCE	CEBOLA	SACI
CAPACETE	CIGARRA	BACIA	CENOURA

ESCREVA PALAVRAS COM AS SÍLABAS INDICADAS.

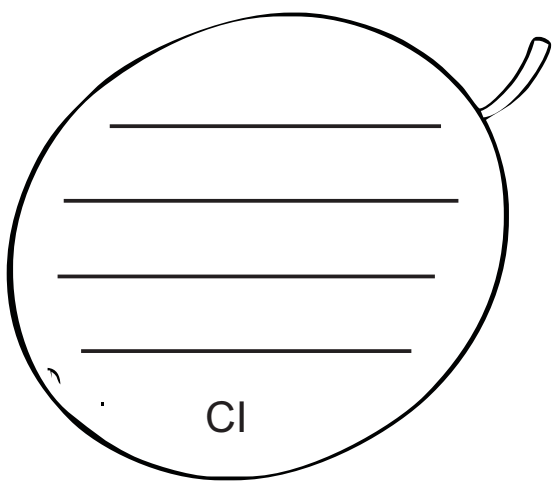
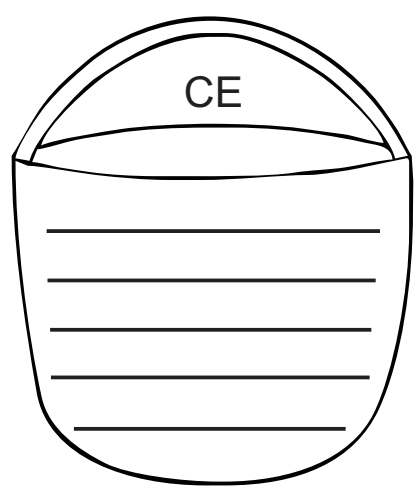

C b v H a B q A C u z m O X



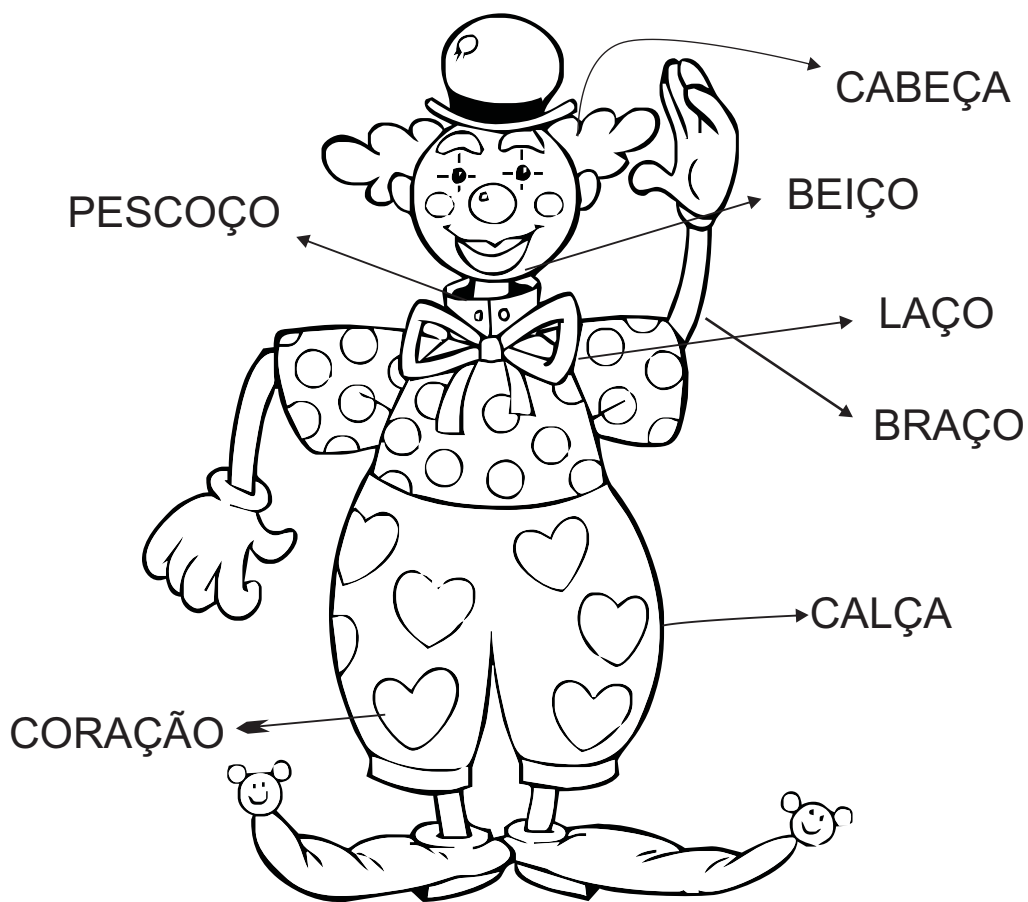









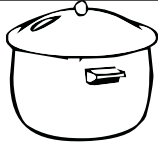
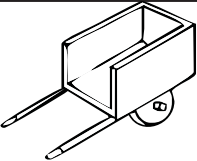

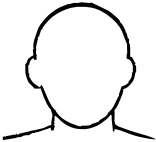
## PALHAÇO BEIÇUDO

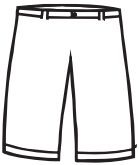
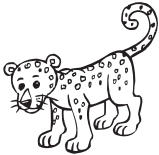

LEIA AS PALAVRAS ESCRITAS, NO PALHAÇO BEIÇUDO. OBSERVE: TODAS TÊM A LETRA Ç. ANTES DAS LETRAS A, O, U; USAMOS A LETRA Ç.

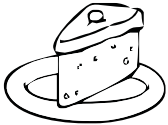
AÇÚCAR	AÇUCENA	MOÇO	BALANÇO
AÇUDE	FUMAÇA	POÇO	TAÇA
CARROÇA	CORAÇÃO	CAÇAROLA	BEIÇO
CABEÇA	EMOÇÃO	OURIÇO	LAÇO
PALHOÇA	CAROÇO	ONÇA	BRAÇO

RECORTE AS PALAVRAS DAS FICHAS E COLE-AS,  
DE ACORDO COM OS NOMES DOS DESENHOS.

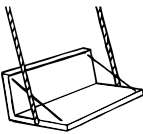
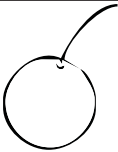
POÇO	TAÇA	DOCE	CAROÇO
BALANÇO	LAÇO	AÇÚCAR	MAÇÃ
CORAÇÃO	CAÇAROLA	ONÇA	CARROÇA
BRAÇO	FUMAÇA	CALÇA	PEDAÇO
CEREJA	PALHAÇO	CABEÇA	MELANCIA



DESCUBRA PALAVRAS COM **ÇA**, **ÇO** E **ÇU** E COPIE-AS AO LADO DO QUADRO. PARA CADA PALAVRA ENCONTRADA, PINTE COM UMA COR DIFERENTE.

PO	PA	LHA	ÇO	CA	_____	_____
MO	ÇO	BRA	ÇO	RO	_____	_____
ÇO	FU	MA	ÇA	ÇO	_____	_____
CA	ÇA	RO	LA	A	_____	_____
MA	ÇÃ	CO	RA	ÇÃO	_____	_____
CA	BE	ÇA	ÇU	CAR	_____	_____

VAMOS DESCOBRIR PALAVRAS NOVAS? ELIMINE A ÚLTIMA LETRA DA PALAVRA E JUNTE O QUE ESTÁ NA FICHA.

ROÇA

CARROÇA

POÇO

EIRO

O QUE ACONTECEU COM A LETRA **Ç** ?

\_\_\_\_\_

\_\_\_\_\_

\_\_\_\_\_

ESCREVA PALAVRAS QUE RIMEM COM:

MOÇO

\_\_\_\_\_ , \_\_\_\_\_ , \_\_\_\_\_

EMOÇÃO

\_\_\_\_\_ , \_\_\_\_\_ , \_\_\_\_\_

MOÇA

\_\_\_\_\_ , \_\_\_\_\_ , \_\_\_\_\_

LEIA AS PALAVRAS DO QUADRO, DEPOIS ESCREVA-AS, DE ACORDO COM O QUE SE PEDE ABAIXO.

CECÍLIA	MELANCIA	OURIÇO	CABEÇA
CORAÇÃO	CEREJA	PESCOÇO	TAÇA
APARECIDO	BRAÇO	CIÇA	ONÇA
AÇUCENA	CIGARRA	ACEROLA	CAÇAROLA
MORCEGO	AÇUCAREIRO	BEIÇO	MAÇÃ

PARTES DO NOSSO CORPO

NOME DE FRUTA

NOME DE FLORES

NOME DE PESSOAS

NOME DE ANIMAIS

NOME DE OBJETOS

LIGUE AS SÍLABAS E ESCREVA AS PALAVRAS.

LA		BA	→	GA				
BRA		CA	→	RO				
MO	→	PES	→	CO	→	ÇO		
PO		BA	→	LAN				
CAL		CHU	→	MA				

a q u b A C S z m X N O p c g v

PINTE AS PALAVRAS DO QUADRO,  
DE ACORDO COM A LEGENDA.

ÇA AZUL    ÇO VERMELHO    ÇU VERDE    ÇÃO AMARELO

CAÇULA	PEDAÇO	MOÇA	EMOÇÃO
LIÇÃO	FUMAÇA	CALÇÃO	CAROÇO
BABAÇU	POÇO	AÇUDE	CALÇA
ONÇA	AÇÚCAR	PESCOÇO	RAÇÃO
LAÇO	CORAÇÃO	TAÇA	AÇUCENA

ESCREVA OS NOMES DOS DESENHOS  
E SEPRE AS PALAVRAS EM SÍLABAS.





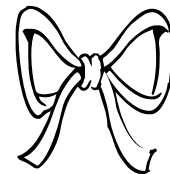
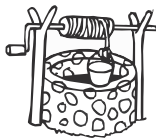



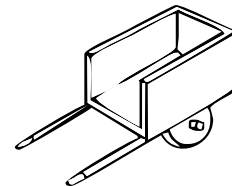
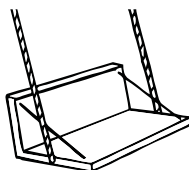
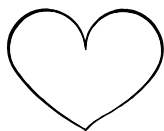

C b v H a B q A C u z m O X

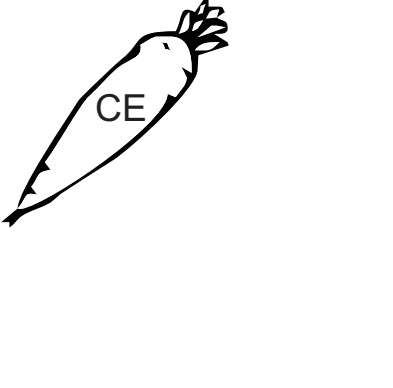
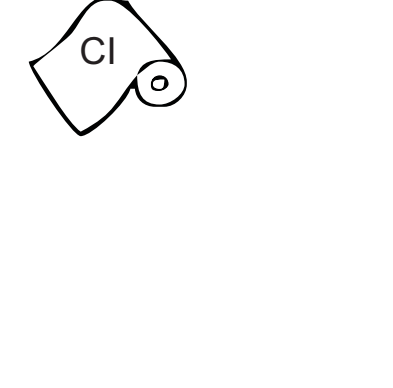
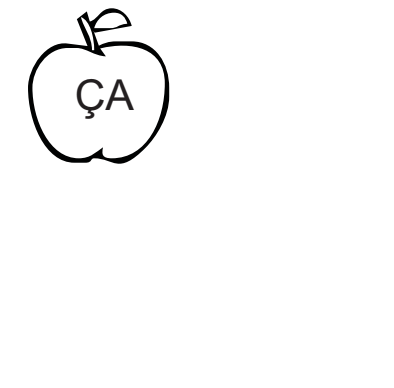
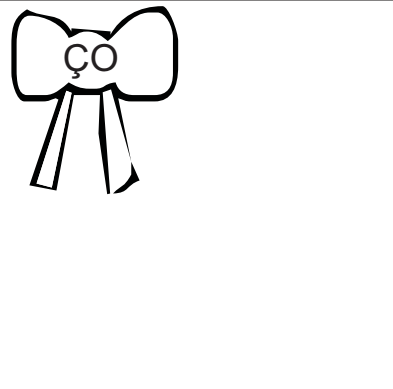
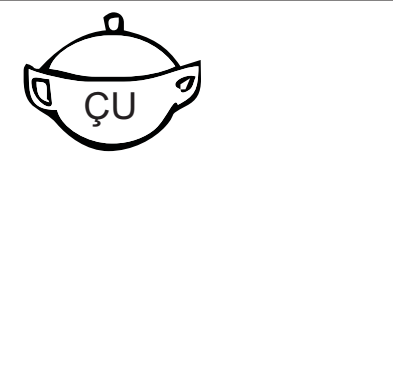

a q u b A C S Z m X N O P C G V  
 p  
 c  
 V  
 O  
 g  
 S  
 a  
 S  
 U  
 D  
 q  
 N  
 G  
 C  
 h  
 C b v H a B q A C u z m O X

LEIA AS PALAVRAS DOS DESENHOS E  
 COPIE-AS NO LUGAR INDICADO.

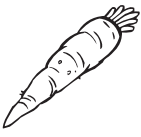

RECORTE E COLE AS FICHAS DAS PALAVRAS,  
DE ACORDO COM AS FAMÍLIAS SILÁBICAS.

	S		CE
	CI		Ç

CEDO	AÇUCENA	MACIO	CIRCO
SEMANA	CINEMA	SÍTIO	DOCE
TAÇA	SACOLA	MOÇO	SOPA
CIDADE	CEBOLA	POLÍCIA	AÇÚCAR
CAPACETE	SUCO	PAÇOCA	CEGONHA

a q u b A C S Z m X N O P C G V

p  
c  
v  
o  
g  
s  
a  
s  
u  
D  
q  
N  
G  
ç  
h

g  
a  
s  
u  
q  
h  
z  
s  
p  
r  
D  
A  
m  
O  
V  
P  
N

### AUTODITADO

ESCREVA PALAVRAS, DE ACORDO COM AS SÍLABAS INDICADAS NOS QUADROS.

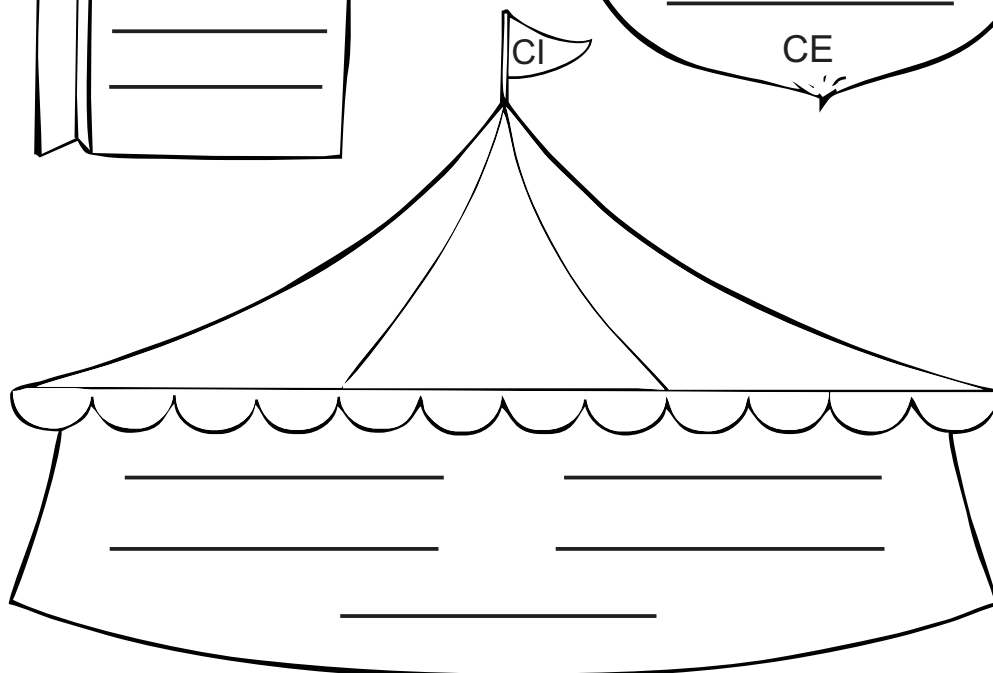
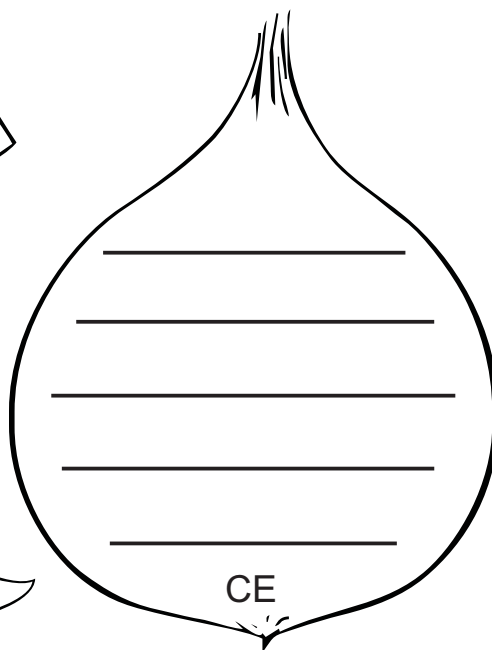
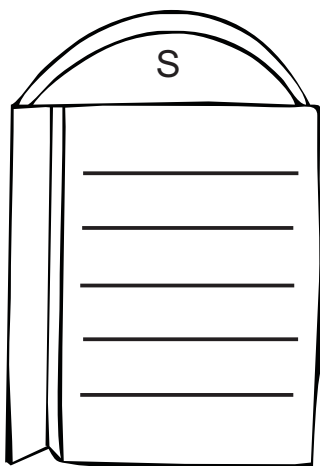
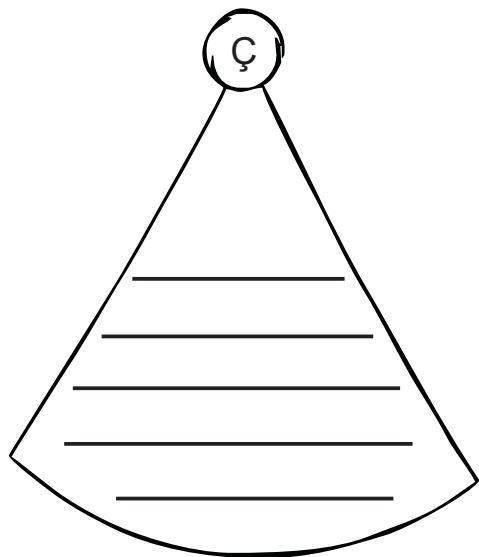

ç b v h a B q A C u z m O X

Q

Q

QUINZINHO CARREGA O QUEIJO,  
TEM DOIS QUIABOS NO CHÃO.  
HIRO TREINA DE QUIMONO.  
ELE QUER SER CAMPEÃO!

NINGUÉM SABE ONDE COMEÇA  
E ONDE TERMINA O FLOQUINHO!  
NO QUADRO, A MÔNICA LISA  
DÁ UM SORRISO DENTUCINHO!

© 2007 - ABC Turma da Mônica: Maurício de Sousa Editora - edição Brasil

CIRCULE NO TEXTO AS PALAVRAS QUE TÊM A LETRA **q - Q**.  
COPIE.

QUEIJO

queijo

queijo

QUE

Que

que

que

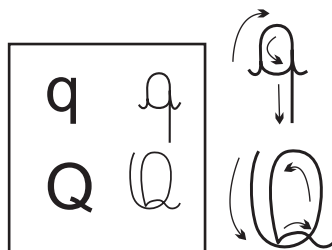
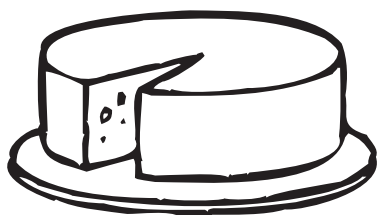

## PERIQUITO MARACANÃ

PERIQUITO MARACANÃ  
CADÊ A SUA IAIÁ,  
FAZ UM DIA, FAZ UM ANO  
QUE EU NÃO VEJO ELA PASSAR.



DOMÍNIO PÚBLICO

CIRCULE NO TEXTO A PALAVRA **PERIQUITO**.

PERIQUITO

periquito

periquito

QUI

Qui

qui

qui

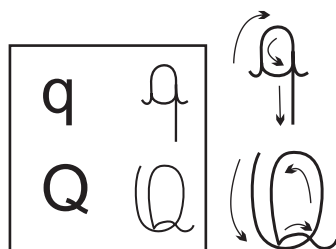

qui	quis	quibe
QUIRINO	caqui	esquilo
máquina	QUITÉRIA	
pequi	quindim	quilo
pequi	aquilo	
quiabo	equipe	







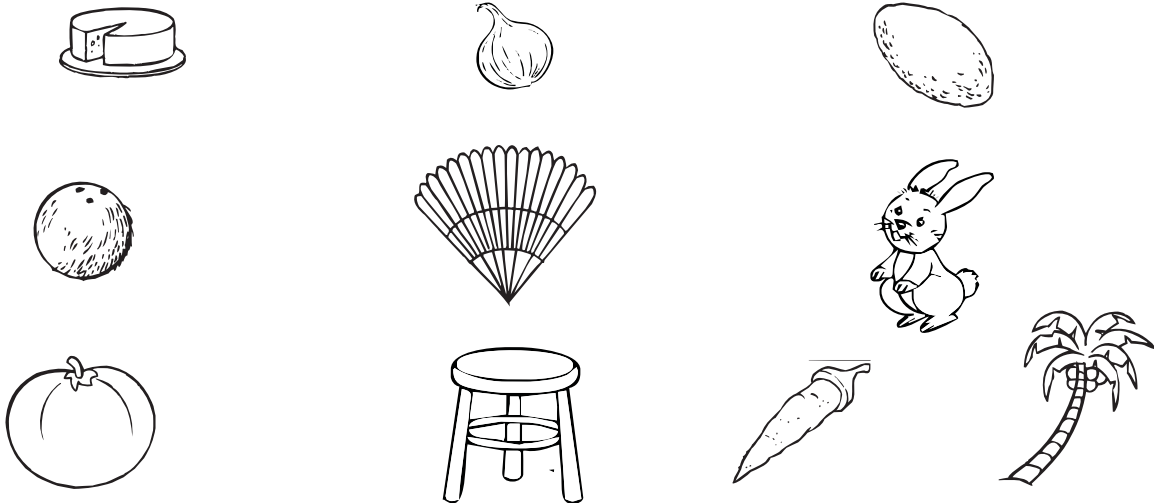

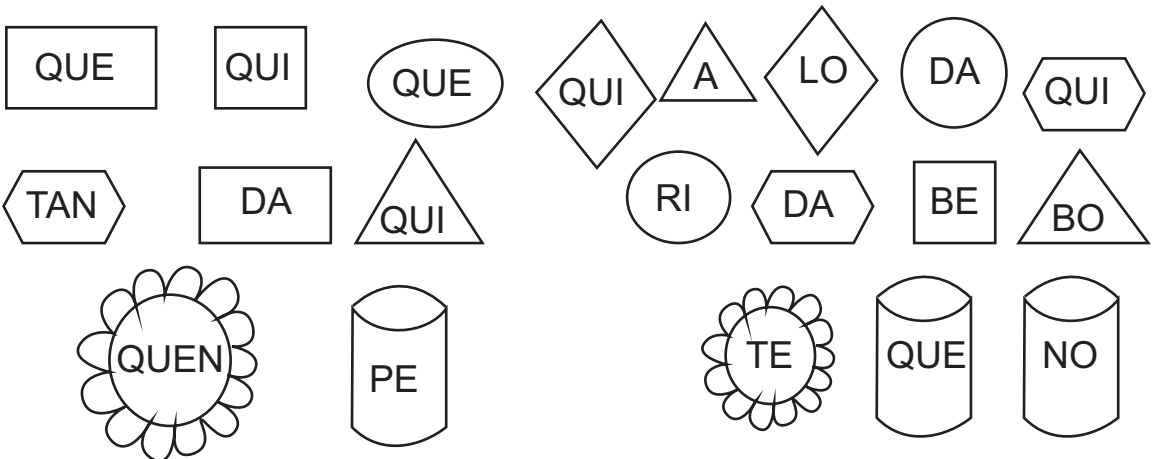

A SÍLABA **QUE** É FORMADA POR TRÊS LETRAS.  
 AO PRONUNCIÁ-LA NÃO OUVIMOS O SOM DO **U**.  
 O MESMO ACONTECE COM A SÍLABA **QUI**.

CIRCULE OS DESENHOS CUJOS NOMES  
 CONTENHAM AS SÍLABAS **QUE** E **QUI**.



JUNTE OS SÍMBOLOS  
 IGUAIS E FORME PALAVRAS.



	_____		_____
	_____		_____
	_____		_____
	_____		_____

PINTE AS SÍLABAS QUE FORMAM AS PALAVRAS DOS DESENHOS E COPIE-AS.

QUI	CI
DO	A
BO	TA

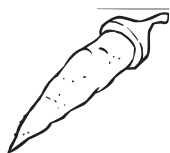

PO	CE
QUEI	BO
GO	JO



CE	LE
LO	BE
QUE	JO

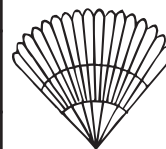

CI	SA
CA	TA
BI	QUI



BU	TO
CE	QUÊ
XO	PE



CO	O
CE	QUEI
RO	BO

BI	QUIN
ZI	DO
DIM	XA



TA	ES
QUI	BI
SE	LO



PE	TI
RI	QUI
TO	BO



LIGUE E ESCREVA AS SÍLABAS, FORMANDO PALAVRAS.

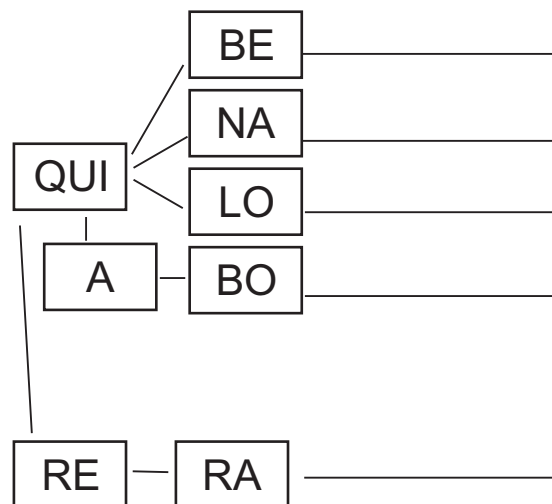
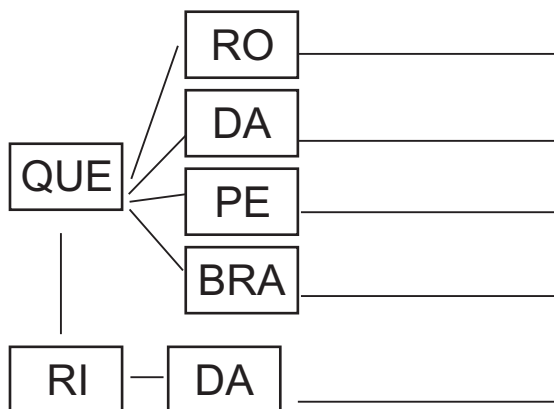

COMPLETE OS NOMES DOS DESENHOS,  
ESCREVENDO **QUE** OU **QUI**.



MÁ \_\_\_\_ NA

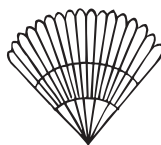

LE \_\_\_\_



PERI \_\_\_\_ TO



CA \_\_\_\_



BAN \_\_\_\_ TA



ES \_\_\_\_ LO

SUBSTITUA OS DESENHOS POR  
PALAVRAS E ESCRIVA AS FRASES.

O



É FEITO DE LEITE.

A COZINHEIRA FEZ SALADA DE



MAMÃE FOI À FEIRA E COMPROU



O



ESTÁ NA GAIOLA.

LEIA AS PALAVRAS DO QUADRO. PINTE AS SÍLABAS **QUE** DE AMARELO E **QUI** DE VERMELHO. COPIE-AS NOS QUADROS ABAIXO, DE ACORDO COM AS SÍLABAS EM DESTAQUE.

QUIMONO	QUEROSENE	QUEIMADURA	QUIETO
QUEIXO	QUEBRADO	QUIABO	QUENTE
QUIBEBE	QUINZE	QUEDA	QUITANDA
QUEIJARIA	QUERMESSE	QUITUTE	QUEIXADA
QUILATE	QUEIXA	QUÍMICA	QUIOSQUE

QUE

QUI

ESCREVA AS PALAVRAS NO DIMINUTIVO.

BOCA - \_\_\_\_\_

COCO - \_\_\_\_\_

BONECA - \_\_\_\_\_

MACACO - \_\_\_\_\_

FACA - \_\_\_\_\_

PORCO - \_\_\_\_\_

PIPOCA - \_\_\_\_\_

LEQUE - \_\_\_\_\_

VACA - \_\_\_\_\_

QUENTE - \_\_\_\_\_

FORME PALAVRAS, COM AS SÍLABAS DOS DESENHOS, QUE CONTENHAM AS SÍLABAS **QUE** OU **QUI**.

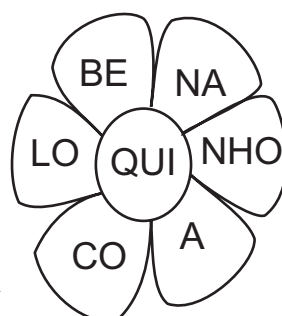
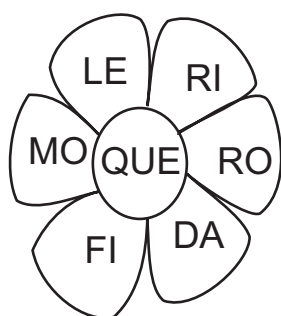

\_\_\_\_\_

\_\_\_\_\_

\_\_\_\_\_

\_\_\_\_\_

a q u b A C S z m X N O p c G V

HORA DO DITADO.

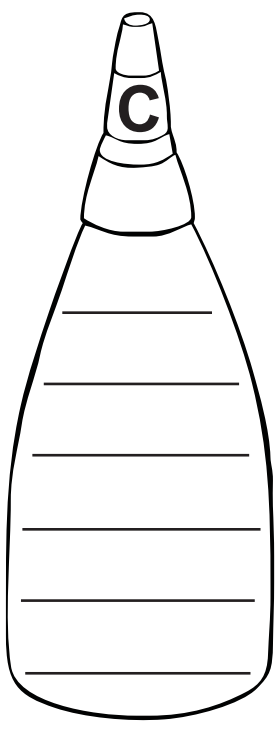
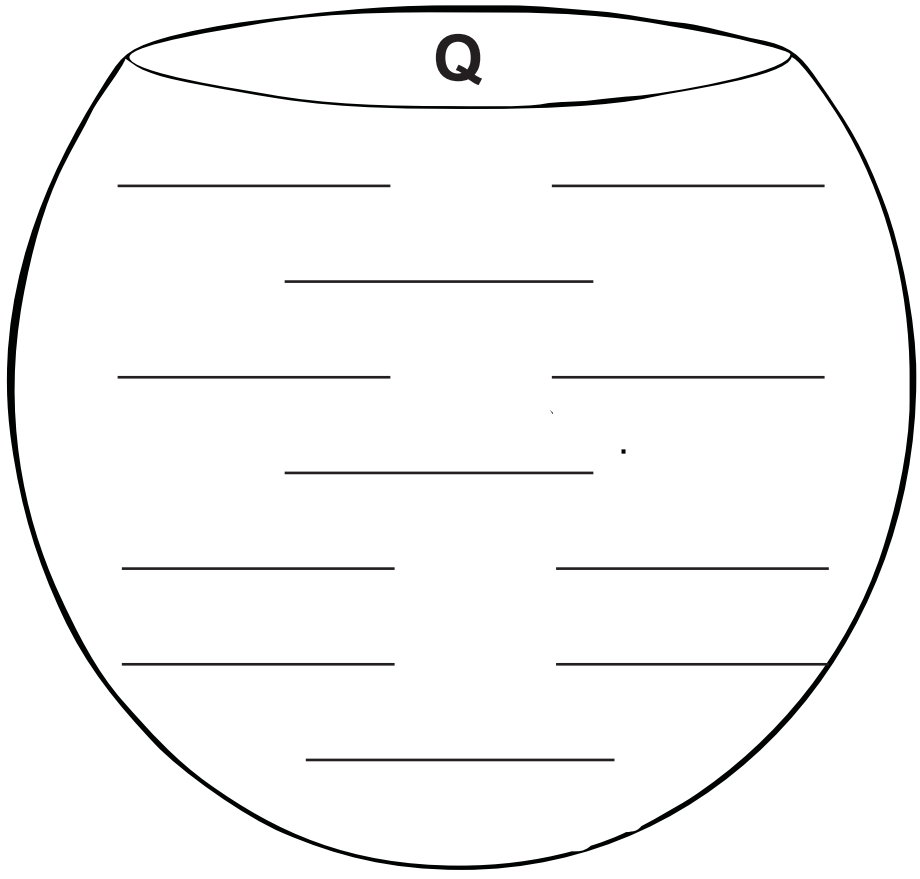

C b v H a B q A C u z m O X

## MARCHA SOLDADO

MARCHA SOLDADO  
CABEÇA DE PAPEL.  
QUEM NÃO MARCHAR DIREITO  
VAI PRESO NO QUARTEL.



QUARTEL PEGOU FOGO  
POLÍCIA DEU SINAL.  
ACODE, ACODE, ACODE  
A BANDEIRA NACIONAL.

(CD AS MAIS BELAS CANTIGAS  
DE RODA, CIRANDA CULTURAL , pág. 9)

CIRCULE NO TEXTO ACIMA, A PALAVRA **QUARTEL**.

COPIE.

QUARTEL

quartel

quartel

Qua

qua

CIRCULE A SÍLABA **QUA**.

4      QUA    qua  
Qua  
quatro

QUATRO	AQUÁRIO
QUARTO	AQUARELA
QUARENTA	QUARTEIRÃO
QUASE	QUARTEL
QUATI	QUADRO
TAQUARA	QUALIDADE
QUANTO	QUANDO

COMPLETE AS PALAVRAS COM AS SÍLABAS **QUA** OU **QUO**.

_____LIDADE	TA_____RA	_____DRADO
_____RENTA	A_____RIO	A_____RELA
_____TI	_____DRO	_____DRA
_____TRO	_____DRILHA	_____SE

JUNTE AS SÍLABAS E FORME PALAVRAS.

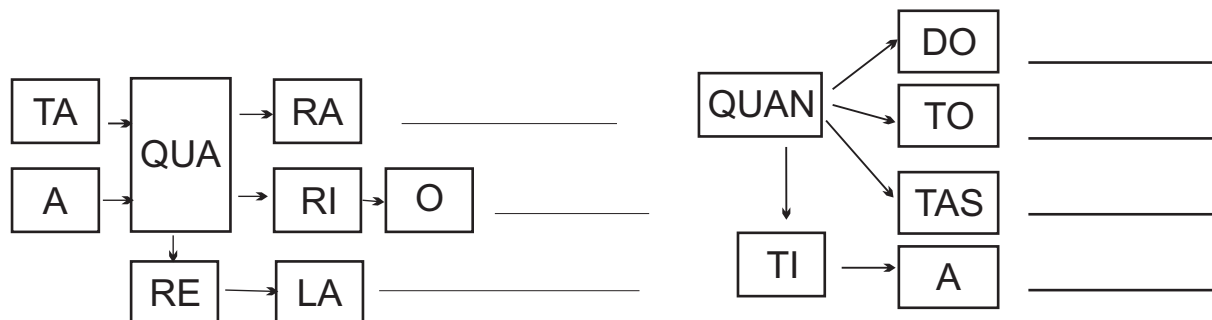

PÉ - DE - MOLEQUE	QUIRINO	TAQUARA
MOQUECA	AQUÁRIO	QUITÉRIA

O NOIVO DE QUITÉRIA É O \_\_\_\_\_.

A CESTA FOI FEITA DE \_\_\_\_\_.

O DOCE DE \_\_\_\_\_ ESTÁ QUENTE.

A \_\_\_\_\_ DE PEIXE ESTÁ DELICIOSA.

O PEIXE NADA NO \_\_\_\_\_.

\_\_\_\_\_ TEM UM LINDO LEQUE.

VAMOS PRÁ SÃO ROQUE

TOQUE, TOQUE, TOQUE  
VAMOS PRÁ SÃO ROQUE.  
VER O MENININHO QUE VEM  
VINDO A GALOPE.

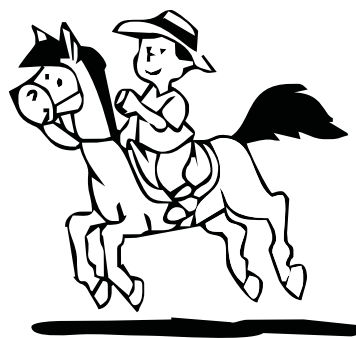

(CD CANTIGAS INFANTIS,  
CIRANDA CULTURAL, pág. 148)

ASSINALE NO TEXTO AS PALAVRAS QUE TÊM  
SÍLABAS COM A LETRA **Q**.

COMPLETE AS PALAVRAS  
COM AS SÍLABAS INDICADAS.

QUE

\_\_\_PE

MU\_\_\_

TO\_\_\_

MOLE\_\_\_

BRE\_\_\_

\_\_\_DA

QUI

\_\_\_LO

\_\_\_TUTE

A\_\_\_

A\_\_\_LO

CA\_\_\_

MÁ\_\_\_NA

E\_\_\_PE

QUA

\_\_\_SE

\_\_\_DRO

\_\_\_DRADO

A\_\_\_RIO

A\_\_\_RELA

\_\_\_TRO

QUO

\_\_\_TA

A\_\_\_SO

\_\_\_RUM

ESCOLHA SEIS PALAVRAS, ESCREVA  
NAS FICHAS SEPARANDO-AS EM SÍLABAS.



LEIA E ESCREVA AS PALAVRAS DE ACORDO COM O QUE SE PEDE NO QUADRO ABAIXO.

ROQUE	ESQUILO	PEQUI	PERIQUITO
COQUINHO	MÁQUINA	QUATRO	QUITÉRIA
LEQUE	QUIRINO	CAQUI	BANQUETA
MOSQUITO	QUARENTA	QUINZE	QUATI

FRUTAS	_____ , _____ , _____
--------	-----------------------

ANIMAIS	_____ , _____ , _____ , _____
---------	-------------------------------

PESSOAS	_____ , _____ , _____
---------	-----------------------

OBJETOS	_____ , _____ , _____
---------	-----------------------

NÚMEROS	_____ , _____ , _____
---------	-----------------------

SUBSTITUA OS DESENHOS PELAS PALAVRAS, E COPIE AS FRASES.

DENTRO DO  TEM UM LINDO PEIXINHO.

RAQUEL TEM  ANOS DE IDADE.

CUSTOU  REAIS O BRINQUEDO DO QUICO.

QUITÉRIA DEU RAÇÃO PARA O  .

ESCREVA OS NOMES DOS DESENHOS.

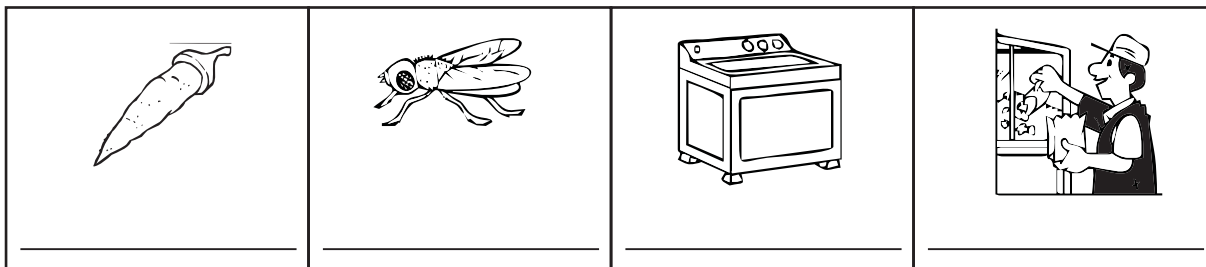
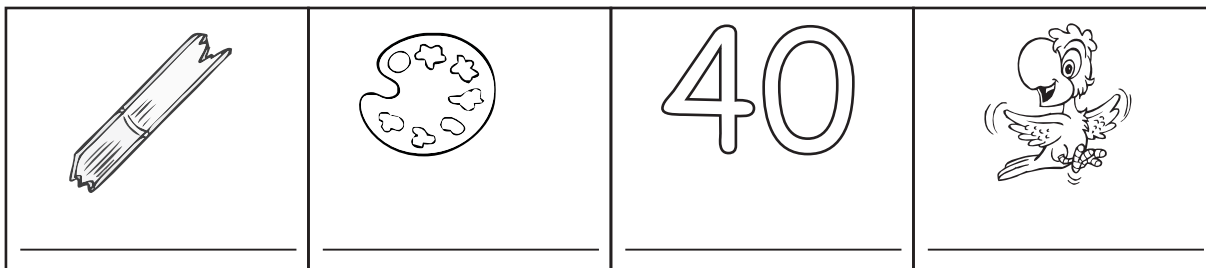
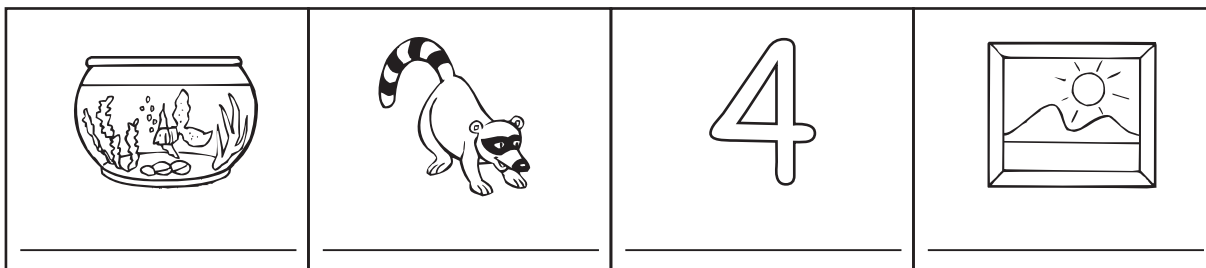

SUBSTITUA OS DESENHOS PELOS NOMES CORRESPONDENTES E COPIE AS FRASES.

ESTÁ CALOR E QUITÉRIA ABANOU-SE COM O

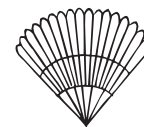

O



É UM ANIMAL MAMÍFERO.

4 E 40 SÃO NÚMEROS ESCRITOS COM A SÍLABA QUA.

O



SALGOU A PIPOCA.

a q u b A C S z m X N O p c G V

**AUTODITADO.**

ESCREVA PALAVRAS, DE ACORDO  
COM A LETRA INDICADA NOS DESENHOS.

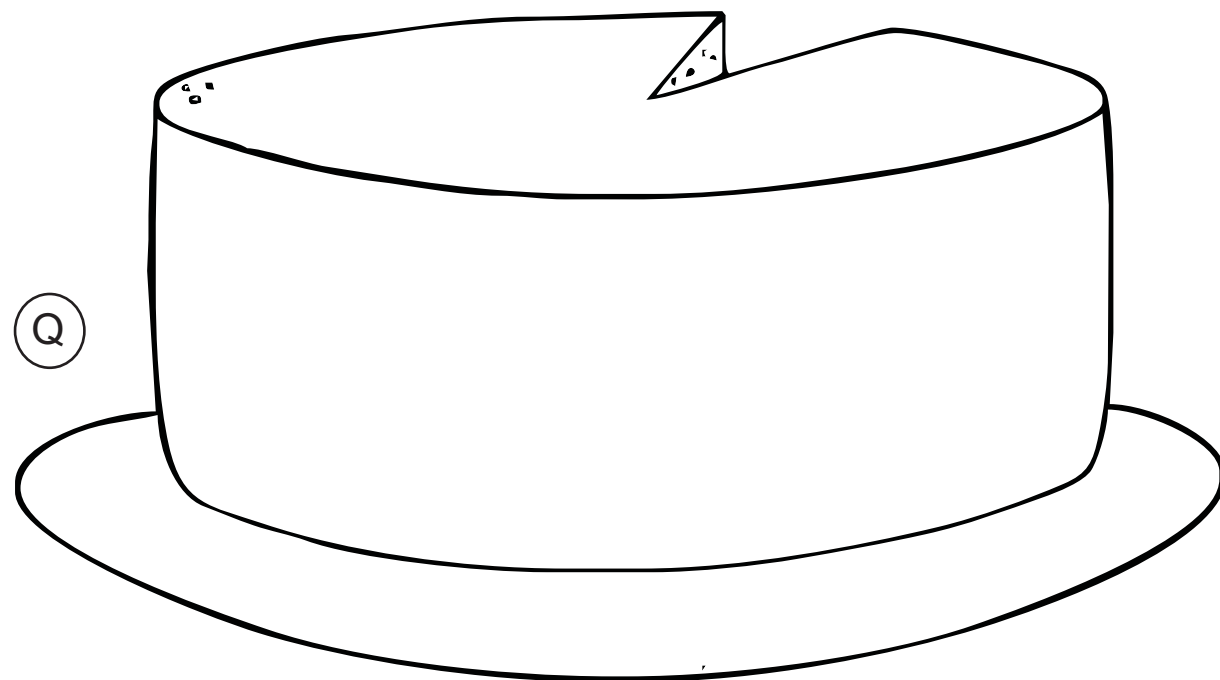
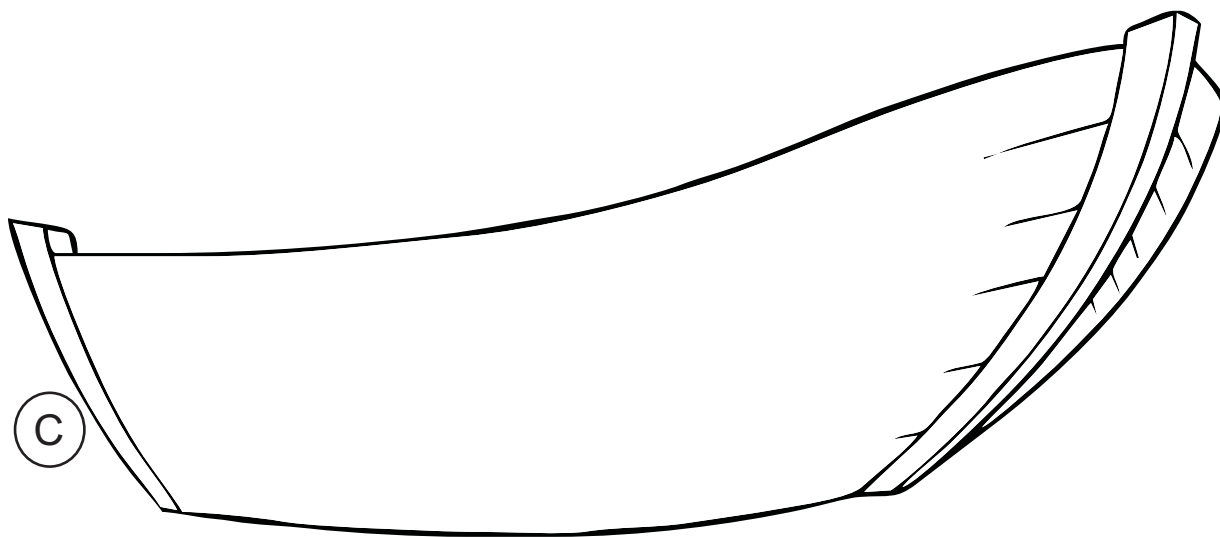

C b v H a B q A C u z m O X

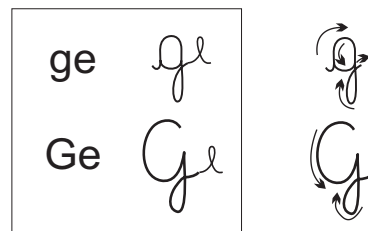

COPIE.

GELADEIRA

geladeira

geladeira

GE - Ge

ge - ge

CIRCULE A SÍLABA **GE** NAS PALAVRAS.

GELO

GELADEIRA

REFRIGERANTE

GEMA

GERENTE

GELATINA

TIGELA

GEMIDO

GEMADA

FOGE

GEADA

GELADO

GEMEU

GELÉIA

GESSO

GELADA

GÊMEA

GENERAL

COM INVEJA DAS CRIANÇAS,  
A GIRAFA ESTICA O PESCOÇO  
E COME UMA NUVEM BRANCA,  
PENSANDO QUE É ALGODÃO  
DOCE.

A ZEBRA, A GIRAFA E OUTROS BICHOS  
MILTON CAMARGO . ED. ÁTICA - 1982

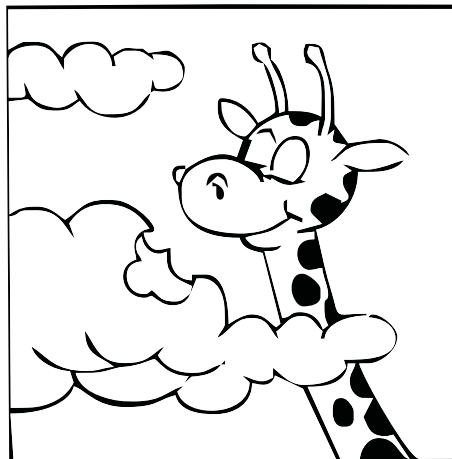

ASSINALE NO TEXTO A PALAVRA **GIRAFA**.

**GIRAFA**

girafa

girafa

**GI** - **GI**

gi - gi

SEPARE AS SÍLABAS DA PALAVRA **GIRAFA**.

**GIRAFA**               

LEIA O QUE PODEMOS ESCREVER COM **GI**.

GIRA

GIRASSOL

GIGANTE

GILETE

GIRO

RELÓGIO

PÁGINA

GIBI

GIRINO

MÁGICA

MAGIA

GÍRIA

COLÉGIO

GENGIVA

REGIME

GIZ

PINTE AS SÍLABAS QUE FORMAM OS NOMES DOS DESENHOS E ESCREVA AS PALAVRAS.



CE GE TO LO

GI MAR A FA

GE TA LA TI NA

GI FI BI

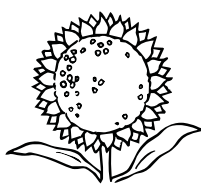

MÁ GI DO CO

GI BE LE TE

GI RAS NOS OL

RELÓ RI GIO



TI DI GELA

CO GE NE MA

VA TA GEM ME

PINTE SOMENTE OS DESENHOS QUE TÊM AS SÍLABAS **GE** E **GI** NAS PALAVRAS.

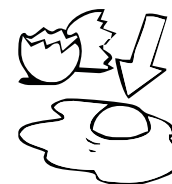
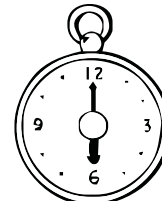
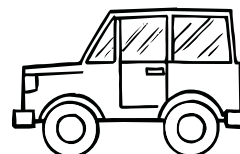

a q u b A C S Z m X N O P C G V

p  
c  
v  
o  
g  
a  
s  
u  
q  
h  
z  
s  
p  
r  
D  
A  
m  
O  
V  
p  
N

g  
a  
s  
u  
q  
h  
z  
s  
p  
r  
D  
A  
m  
O  
V  
p  
N

FORME PALAVRAS.

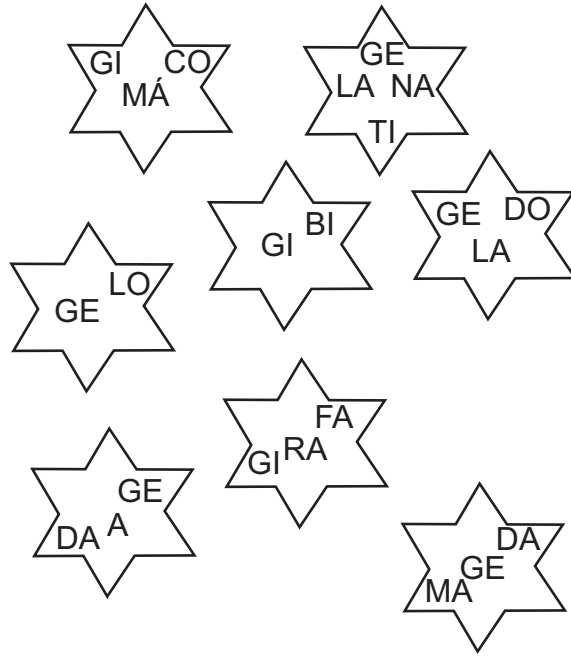

\_\_\_\_\_

\_\_\_\_\_

\_\_\_\_\_

COMPLETE AS SÍLABAS QUE FALTAM NAS PALAVRAS.

___LO	___MADA	___RA	___LETE
MÁ___CO	MA___A	___LATINA	___LADO
___MIDO	___MA	___GANTE	___NÁSIO
A___LIDADE	___ENTE	RELÓ___O	TI___LA
___RASSOL	___LADEIRA	___BI	MÁ___CA

C b v h a B q A C u z m O X

FORME PALAVRAS, JUNTANDO OS SÍMBOLOS IGUAIS.

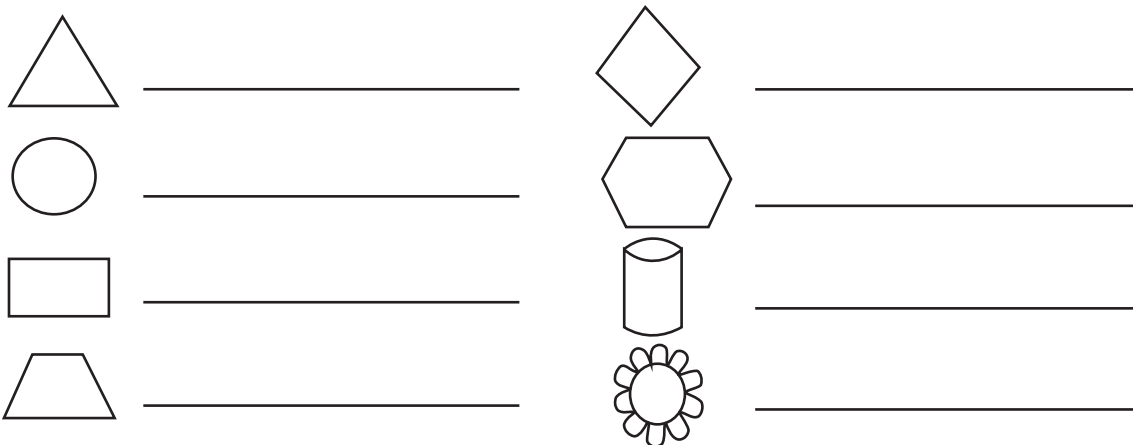
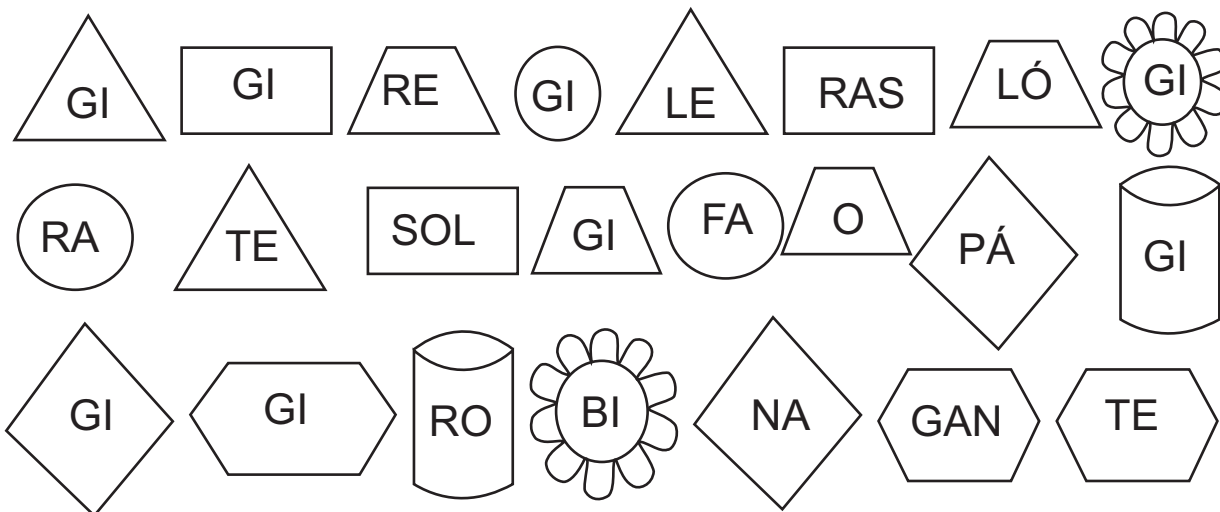

LIGUE AS SÍLABAS FORMANDO PALAVRAS.

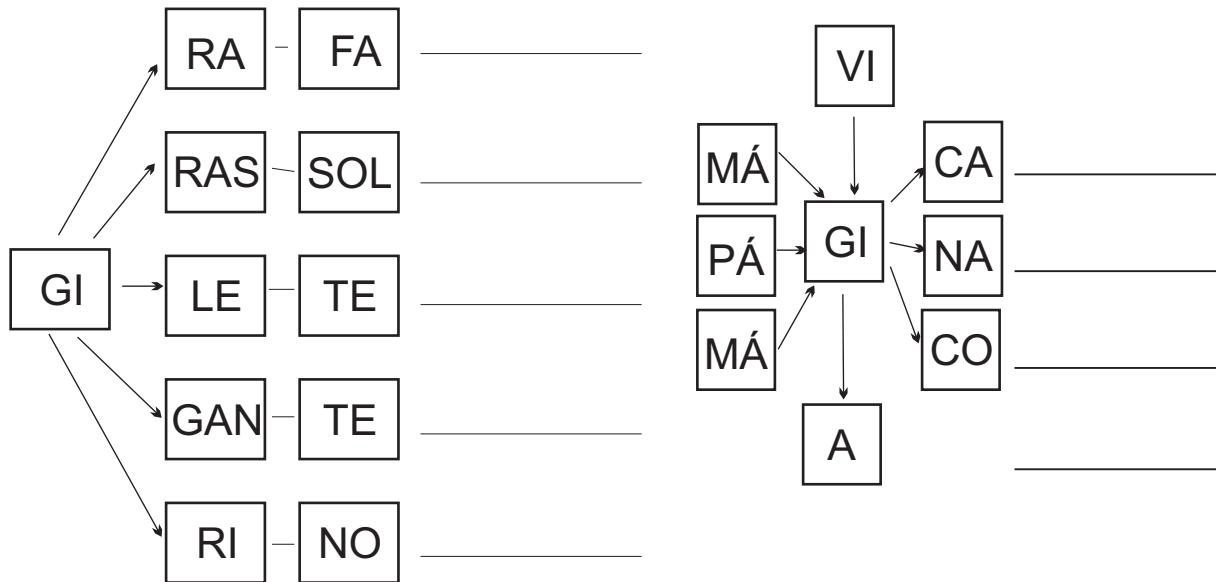



a q u b A C S Z m X N O P C G V  
p  
c  
v  
o  
g  
s  
a  
s  
u  
D  
q  
N  
G  
h  
C b v h a B q A C u z m o X

COMPLETE COM AS LETRAS **J** OU **G**.

- \_\_\_ ECA    \_\_\_ ATO    \_\_\_ EADA
- \_\_\_ ELO    \_\_\_ IBI    \_\_\_ EMA
- \_\_\_ IRAFA    \_\_\_ ACA    \_\_\_ ELADEIRA
- \_\_\_ EITO    \_\_\_ IRO    \_\_\_ ABÁ
- \_\_\_ OIABA    \_\_\_ ILETE    \_\_\_ IBÓIA
- \_\_\_ IPE    \_\_\_ ILÓ    \_\_\_ IGANTE

FORME PALAVRAS COM AS SÍLABAS  
ESCONDIDAS NAS PINTAS DA GIRAFA.

\_\_\_\_\_

\_\_\_\_\_

\_\_\_\_\_

\_\_\_\_\_

\_\_\_\_\_

\_\_\_\_\_



CRUZA-PALAVRAS.

- GIBI
- TIGELA
- RELÓGIO
- GELO
- GELADEIRA
- GEMA
- GIRAFÁ
- MÁGICO

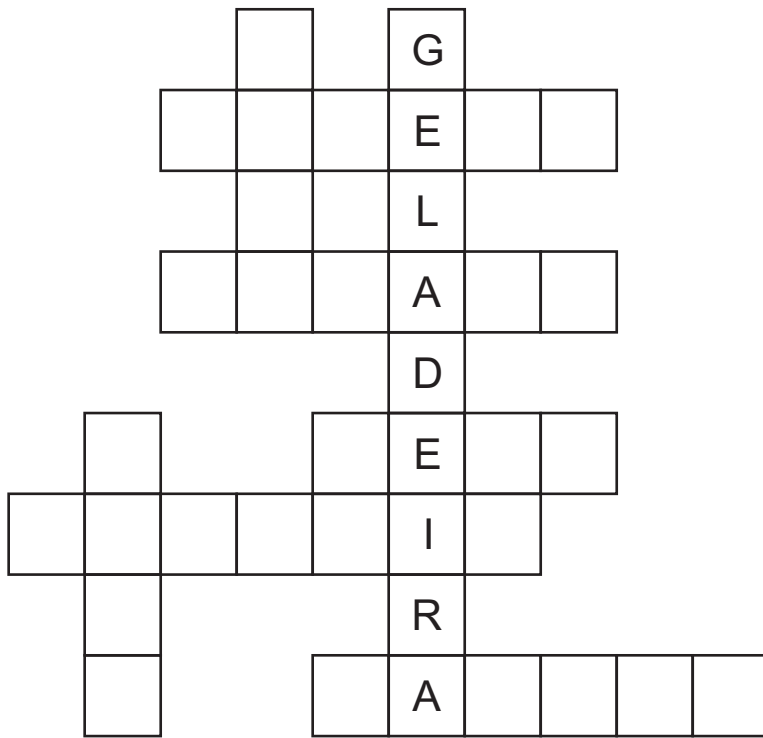

SUBSTITUA OS DESENHOS PELAS PALAVRAS CORRESPONDENTES E ESCREVA AS FRASES.

A  DO OVO É AMARELA.

---

A  TEM O PESCOÇO COMPRIDO.

---

GIGI FEZ  DE ABACAXI.

---

O NOME DO  É ROGÉRIO.

---

ADIVINHE.  
 SOU FEITO DE ÁGUA, MAS SE NELA VOCÊ ME JOGAR  
 COM CERTEZA NÃO VAI ME ACHAR. (O GELO)

LEIA AS PALAVRAS E ESCREVA NOS DESENHOS,  
OBSERVANDO AS SÍLABAS INDICADAS.

GEADA	GÍRIA	COLÉGIO	GIRO
REGIME	GESTO	AGILIDADE	GESSO
VAGEM	MUGIDO	GEMIDO	GENGIVA

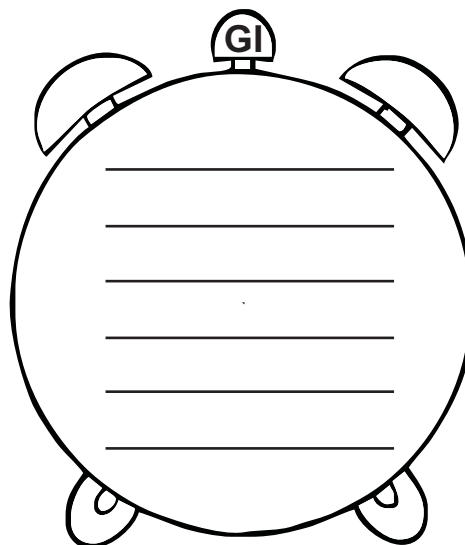
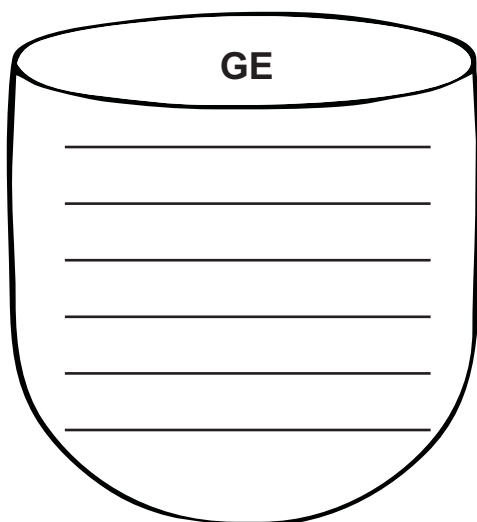

COMPLETE AS PALAVRAS COM **GE** OU **GI**.  
DEPOIS, SEPRE-AS EM SÍLABAS.

__MADA	MÁ__CA	__LETE	__LÉIA
__LADEIRA	TI__LA	VI__A	RELÓ__O
__ADA	ZOOLÓ__CO	__MIDO	__RAFA

ADIVINHE:  
GIRA, GIRA E NÃO PODE PARAR.  
GIRA, GIRA E NÃO SAI DO LUGAR.

(O RELÓGIO)

LEIA AS PALAVRAS DO QUADRO E  
ESCREVA-AS NAS FRASES ABAIXO.

GEMA	GIRASSOL	MÁGICO	PÁGINA
GELO	GILETE	GIRAFA	RELÓGIO

TODO LIVRO TEM \_\_\_\_\_.

O PAPAÍ USA A \_\_\_\_\_ PARA FAZER A BARBA.

O \_\_\_\_\_ É UMA FLOR AMARELA.

MEU \_\_\_\_\_ ESTÁ SEM BATERIA.

O OVO TEM A CLARA E A \_\_\_\_\_.

O \_\_\_\_\_ DA GELADEIRA DERRETEU.

GIGI É O NOME DA \_\_\_\_\_ DO ZOOLOGICO.

QUEM FAZ MÁGICAS É O \_\_\_\_\_.

CAÇA-PALAVRAS

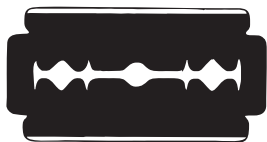

W	Y	K	G	E	M	A	Q
T	Z	G	E	L	O	R	G
I	B	I	L	K	P	S	I
G	I	R	A	S	S	O	L
E	C	A	T	J	T	V	E
L	D	F	I	L	X	Z	T
A	H	A	N	W	K	K	E
F	M	N	A	Y	G	I	Z
A	E	B	F	C	G	D	H

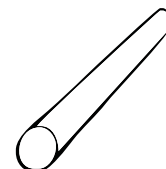
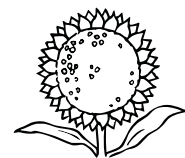

GEMA	GIRASSOL	GELATINA	GIZ
GILETE	TIGELA	GIRAFA	GELO

a q u b A C S Z m X N O P C G V

AUTODITADO.

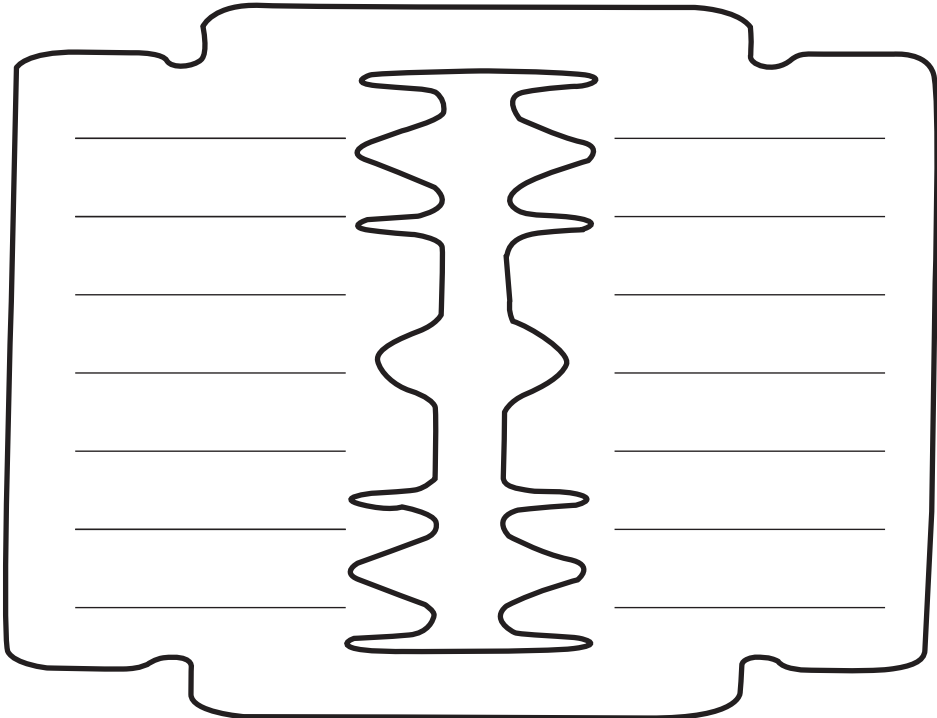
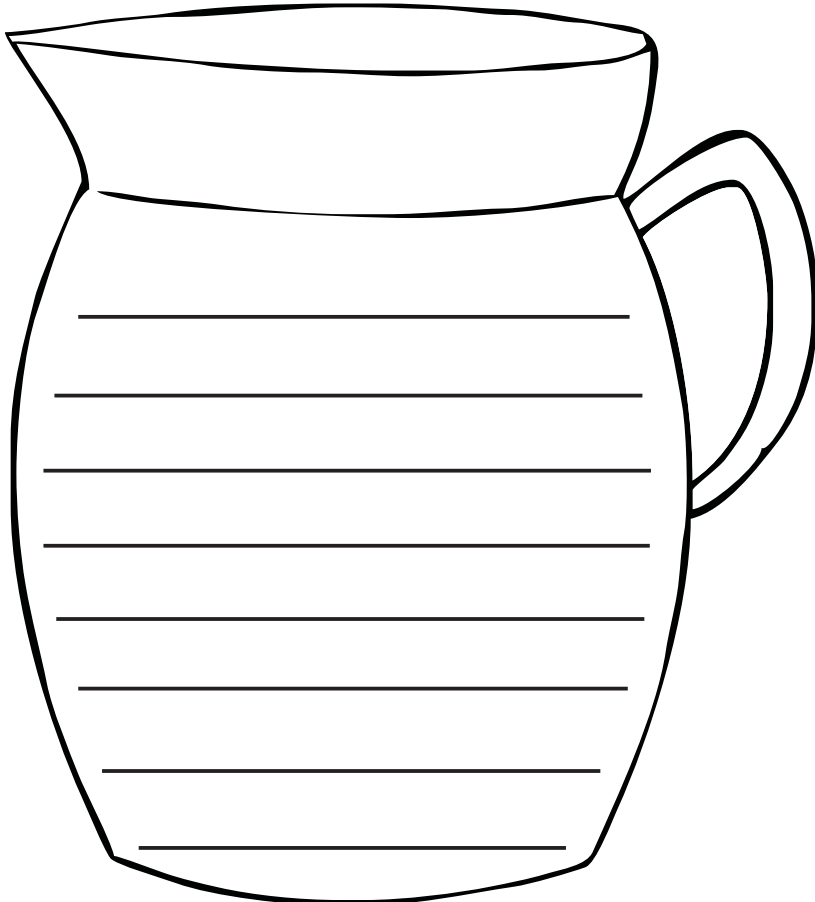

C b v H a B q A C u z m O X

## CARANGUEJO

CARANGUEJO NÃO É PEIXE,  
CARANGUEJO PEIXE É.  
CARANGUEJO SÓ É PEIXE  
NA ENCHENTE DA MARÉ.  
ORA PALMA, PALMA, PALMA  
ORA PÉ, PÉ, PÉ.  
ORA RODA, RODA, RODA,  
CARANGUEJO PEIXE É.

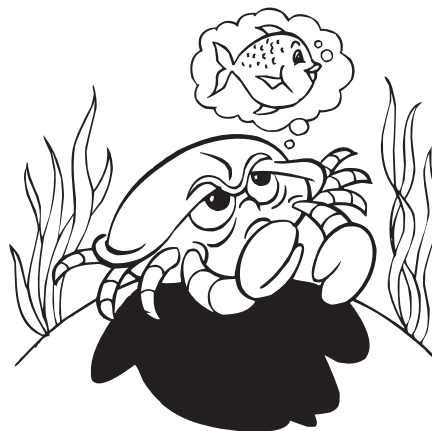

CD CANTIGAS INFANTIS,  
CIRANDA CULTURAL pág.102)

CIRCULE NO TEXTO A PALAVRA **CARANGUEJO**.

COPIE.

CARANGUEJO

caranguejo

caranguejo

gue - gue

GUE - Gue

foguete

fogueira

acougue

guerreiro

queixa

guerra

mangue

figueira

gueto

gue

gue

GUE

Gue

BOM DIA, AMIGUINHO, COMO VAI?

BOM DIA, AMIGUINHO, COMO VAI?

A NOSSA AMIZADE NUNCA SAI.

FAREMOS O POSSÍVEL PARA

SERMOS BONS AMIGOS.

COMO VAI, AMIGUINHO, COMO VAI?

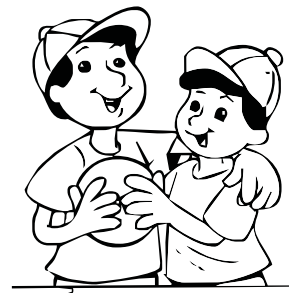

(CD AS MAIS BELAS CANTIGAS DE RODA,  
CIRANDA CULTURAL, pág.27.)

CIRCULE NO TEXTO, A PALAVRA **AMIGUINHO**.

COPIE.

AMIGUINHO

amiguinho

amiguinho

gui - gui

GUI - Gui

guia

guisado

guiné

quichê

GUIDO

guincho

guirlanda

guizo

amiguinho

GUILHERME

águia

gui

gui

GUI

Gui

LEIA AS PALAVRAS E COPIE-AS, NO QUADRO INDICADO, DE ACORDO COM AS SÍLABAS **GUE** E **GUI**.

GUIA	FOGUETE	ALGUÉM	MANGUEIRA
GUERRA	GUIZO	GUIOMAR	SANGUE
ÁGUIA	AÇOUGUE	GUISADO	FOGUEIRA
FORMIGUEIRO	GUINDASTE	FIGUEIRA	GUITARRA

**GUE**

**GUI**

ESCREVA AS PALAVRAS DESTACADAS, NO LUGAR CORRETO.

COLEGUINHA - GUIZINHO - FOGUINHO - AMIGUINHO
JOGUINHO - GUISADINHO - GUITARRINHA - FOGUETINHO

AMIGO \_\_\_\_\_

FOGO \_\_\_\_\_

GUIZO \_\_\_\_\_

COLEGA \_\_\_\_\_

FOGUETE \_\_\_\_\_

JOGO \_\_\_\_\_

GUISADO \_\_\_\_\_

GUITARRA \_\_\_\_\_



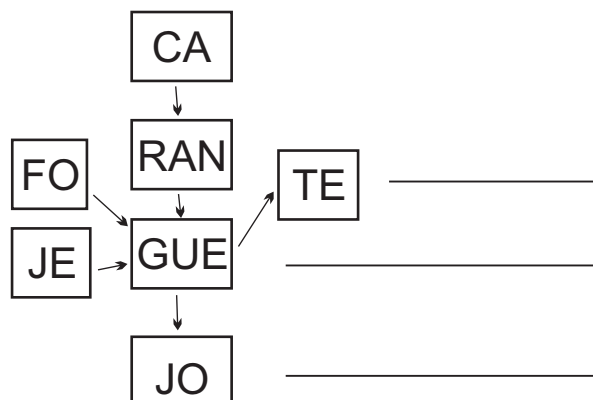
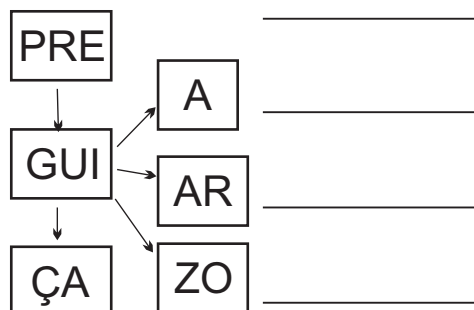







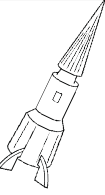

LIGUE.



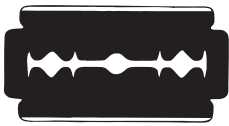

a q u b A C S z m X N O p c g v

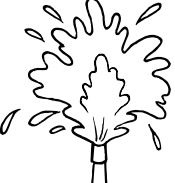
PINTE OS DESENHOS QUE TÊM NO NOME A SÍLABA EM DESTAQUE.

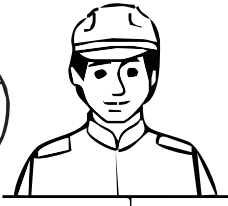
GUE					
GUI					
GUA					

LIGUE E FORME PALAVRAS.

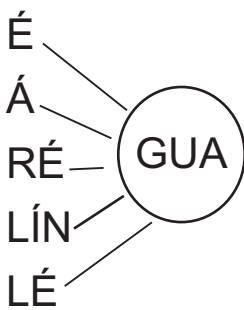

\_\_\_\_\_

\_\_\_\_\_

\_\_\_\_\_

\_\_\_\_\_

\_\_\_\_\_

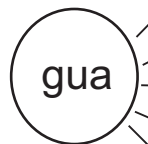

RÁ \_\_\_\_\_

RANÁ \_\_\_\_\_

RANI \_\_\_\_\_

BIROBA \_\_\_\_\_

RITA \_\_\_\_\_

JE JO

FO TE

*que*

FI FO

MAN RA

*qui*

A PRE

MI NHO

PRE ÇA

*qui*

\_\_\_\_\_

\_\_\_\_\_

\_\_\_\_\_

\_\_\_\_\_

\_\_\_\_\_

\_\_\_\_\_

\_\_\_\_\_

\_\_\_\_\_

\_\_\_\_\_

\_\_\_\_\_

\_\_\_\_\_

\_\_\_\_\_

\_\_\_\_\_

\_\_\_\_\_

\_\_\_\_\_

C b v H a B q A C u z m O X

COMPLETE AS FRASES COM  
A PALAVRA ADEQUADA.

JOGUINHO - GUITARRA - GUARITA

GUIDO GOSTA DE TOCAR \_\_\_\_\_.

GUERRA - QUIABO - GUISADO

AGUINALDO COMEU TODO O \_\_\_\_\_ DE CARNE.

AÇOUGUE - MANGUE - SANGUE

OS CARANGUEJOS GOSTAM DE MORAR NO \_\_\_\_\_.

GUIZO - GUITARRA - RÉGUA

O GATO GUIGUI TEM UM \_\_\_\_\_ NO PESCOÇO.

CARANGUEJO - SAGUÃO - GUARANI

O \_\_\_\_\_ DO HOTEL ESTÁ TODO ENFEITADO.

ÁGUIA - ÉGUA - ÁGUA

DEVEMOS FILTRAR A \_\_\_\_\_ PARA BEBER.

COMPLETE AS PALAVRAS.

GUE

GUI

GUA

CARAN\_\_JO

Á\_\_A

Á\_\_

AL\_\_M

\_\_NDASTE

RÉ\_\_

SAN\_\_

\_\_A

\_\_RDA

\_\_RRA

\_\_TARRA

\_\_RANÁ

AÇO\_\_

AMI\_\_NHO

É\_\_

FO\_\_IRA

\_\_ZO

\_\_RITA

MAN\_\_IRA

\_\_SADO

LÍN\_\_

FI\_\_IRA

ES\_\_CHO

\_\_RANI

JE\_\_

JO\_\_NHO

ESCREVA AS FRASES SUBSTITUINDO OS DESENHOS POR PALAVRAS.

VOVÔ REGA O JARDIM COM A  .

A  ESTÁ CARREGADA DE MANGAS MADURAS.

O  CUIDA DO TRÂNSITO.

O  VIVE NO MANGUE.

SEPARE AS PALAVRAS EM SÍLABAS E COPIE-AS.

FOGUETE

GUITARRA

GUERRA

MANGUEIRA

GUIZO

JOGUINHO

JEGUE

SANGUE

COMPLETE AS EXPRESSÕES.

(PROFESSOR, DISCUTA COM AS CRIANÇAS A DIFERENÇA ENTRE CADA EXPRESSÃO).

- \_\_\_\_\_ - CHUVA
- \_\_\_\_\_ - ROUPA
- \_\_\_\_\_ - COMIDA
- \_\_\_\_\_ - SOL
- \_\_\_\_\_ - PÓ
- \_\_\_\_\_ - COSTAS

- \_\_\_\_\_ - NOTURNO
- \_\_\_\_\_ - FIO
- \_\_\_\_\_ - JÓIA
- \_\_\_\_\_ - LIVROS
- \_\_\_\_\_ - CHAVES
- \_\_\_\_\_ - FLORESTAL

LEIA AS PALAVRAS DOS QUADROS  
E FAÇA UM DESENHO SOBRE ELAS.

ÁGUA

RÉGUA

GUARITA

GUARDA - CHUVA

GUARDANAPO

GUARANÁ

ÉGUA

GUARDA

LEIA AS PALAVRAS E ESCREVA-AS  
COMPLETANDO AS EXPRESSÕES.

ÁGUA	GUARDANAPO	GUARDA	GUARANI
GUARANÁ	MANGUEIRA	GUARÁ	GUARITA

\_\_\_\_\_ - CHUVA

TUPI-\_\_\_\_\_

BANHO DE \_\_\_\_\_

APITO DO \_\_\_\_\_

\_\_\_\_\_ DA MANGUEIRA

GARRAFA DE \_\_\_\_\_

\_\_\_\_\_ DE TRÂNSITO

\_\_\_\_\_ DE PAPEL

\_\_\_\_\_ DO GUARDA





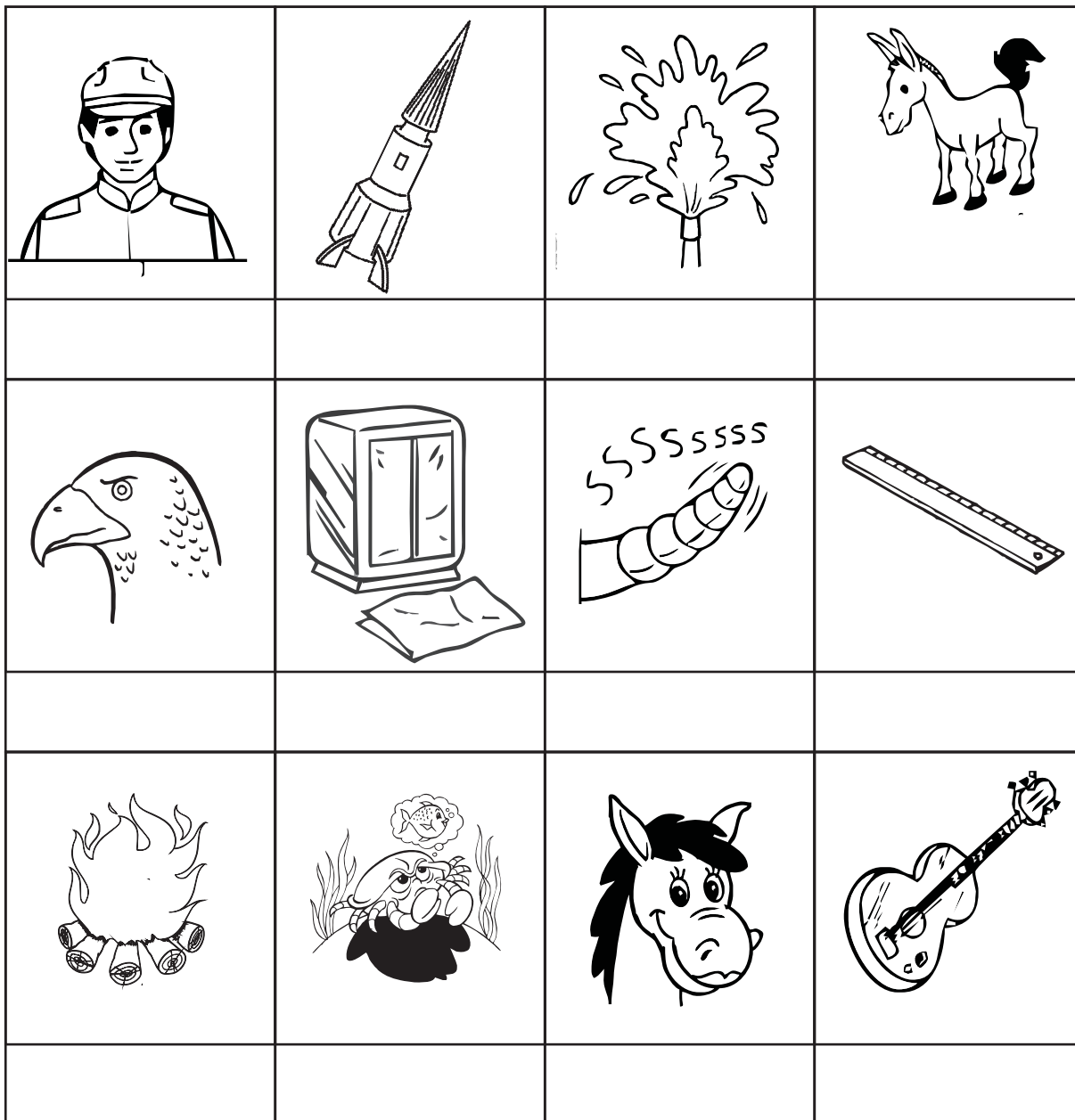

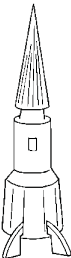

LOBO-\_\_\_\_\_

RECORTE AS FICHAS DAS PALAVRAS E  
COLE-AS DE ACORDO COM OS DESENHOS.

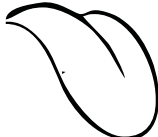
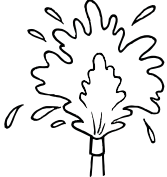
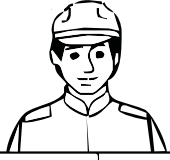

GUIZO	ÁGUA	CARANGUEJO	FOGUETE
GUARDA	FOGUEIRA	ÉGUA	GUITARRA
ÁGUA	GUARDANAPO	RÉGUA	JEGUE

LIGUE O DESENHO QUE CORRESPONDE A ESCRITA.

		FOGUETE	
		ÉGUA	
		AGULHA	
		QUEIJO	
		GELATINA	
		FOGUEIRA	
		ÁGUA	
		GUIZO	
		QUIABO	
		GILETE	
		LÍNGUA	
		GUARDA	

COMPLETE AS PALAVRAS COM A SÍLABA ADEQUADA.

GE - GI - GUE - GUI - CE - CI - QUE - QUI

\_\_\_LATINA

SAN\_\_\_

\_\_\_BOLINHA

\_\_\_RIDA

\_\_\_RAFA

\_\_\_TARRA

\_\_\_DADE

A\_\_\_LO

\_\_\_NEMA

\_\_\_TUTE

TI\_\_\_LA

AÇOU\_\_\_

FO\_\_\_TE

CARAN\_\_\_JO

COLE\_\_\_NHA

CAÇA-PALAVRAS.

K	L	I	N	G	Ü	I	Ç	A	Z
W	Z	Q	G	U	A	R	A	N	I
X	P	K	U	I	L	S	V	P	É
Á	G	U	A	A	Í	T	X	I	G
G	U	A	R	A	N	Á	W	N	U
U	R	S	D	P	G	G	K	G	A
A	V	X	A	Q	U	U	R	Ü	C
R	Z	W	S	Y	A	I	T	I	W
D	Y	K	O	T	Q	A	Z	M	X
A	L	M	L	P	S	A	G	Ü	I

ÁGUA  
 LÍNGUA  
 LINGÜIÇA  
 GUARDA  
 ÉGUA  
 GUIA  
 ÁGUIA  
 SAGÜI  
 GUARANÁ  
 GUARANI  
 GUARDA-SOL  
 PINGÜIM

DOMINOX.

GUIZO  
 ÉGUA  
 GUIA  
 LINGÜIÇA  
 SAGÜI  
 PINGÜIM  
 ÁGUA  
 GUARANÁ  
 ÁGUIA

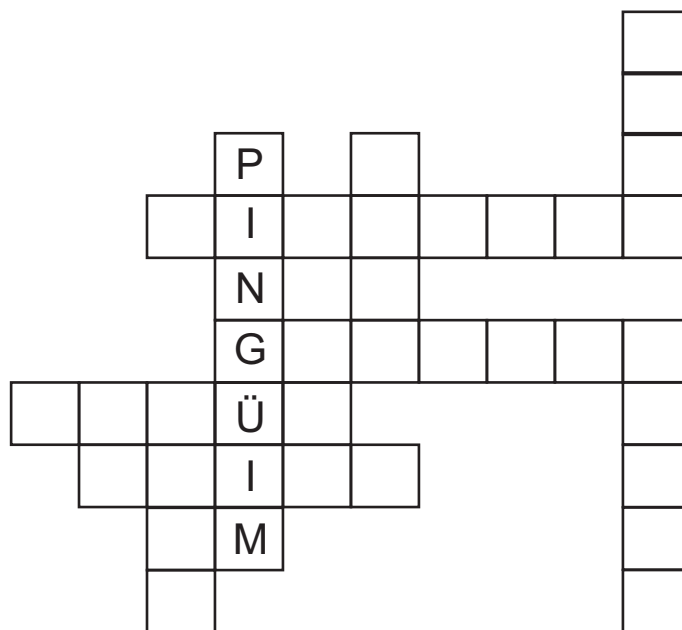

a q u b A C S z m X N O p c G V

AUTODITADO.

GE - GI

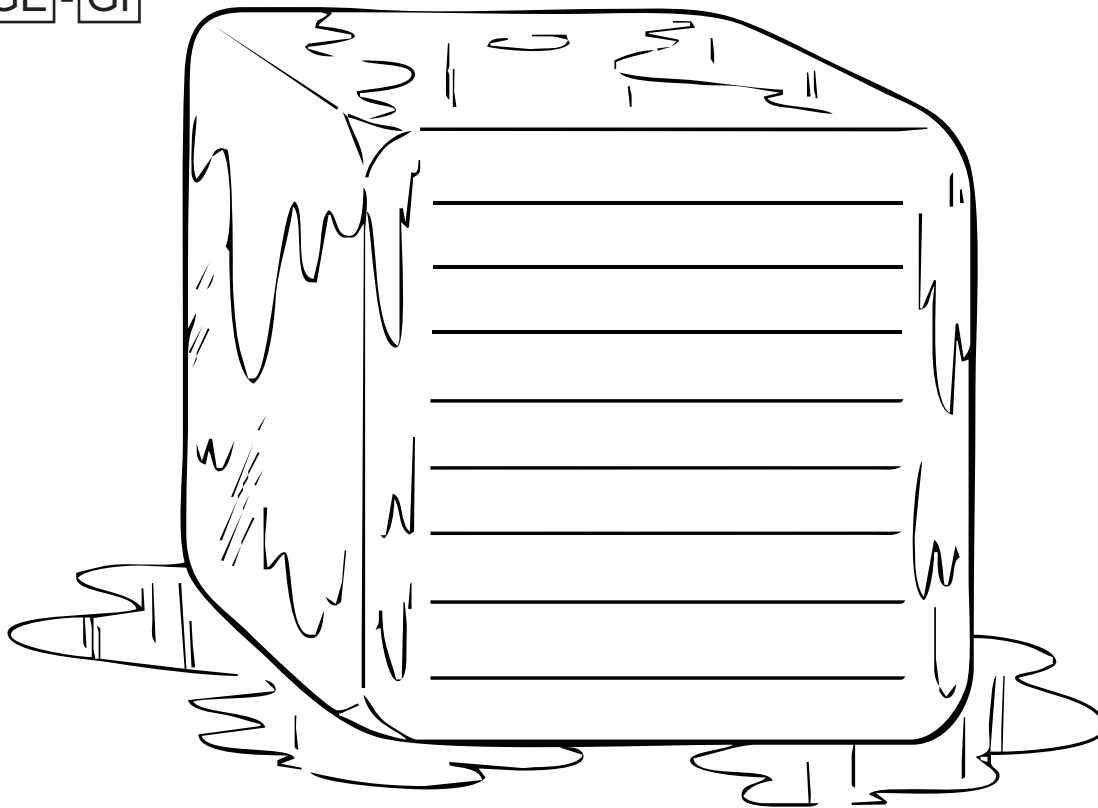

GUE - GUI

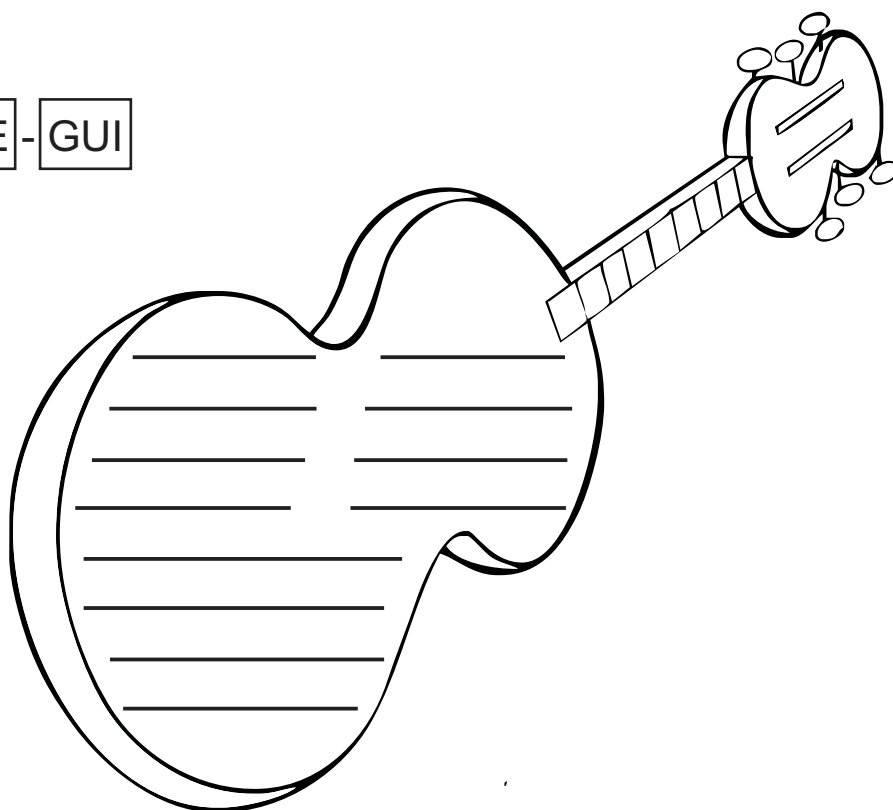

C b v H a B q A C u z m O X



a q u b A C S Z m X N O P C G V  
p  
c  
L  
O  
g  
S  
a  
S  
U  
D  
q  
N  
G  
h  
C  
b v h a B q A C u z m O X

**NA BAHIA TEM**

NA BAHIA TEM,  
TEM, TEM, TEM!  
NA BAHIA TEM, MORENA  
COCO DE VINTÉM.

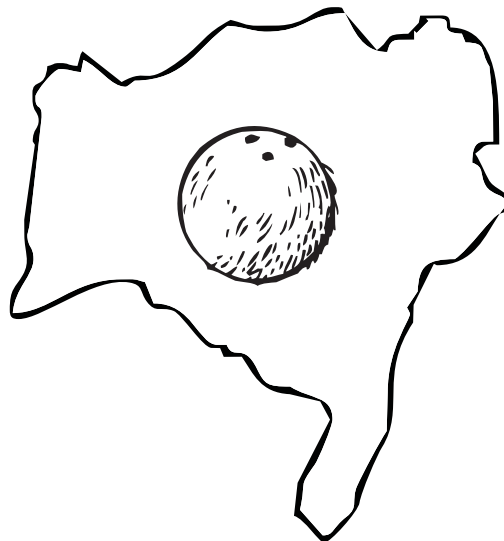

CD CANTIGAS INFANTIS,  
CIRANDA CULTURAL, pág. 136

ASSINALE NO TEXTO A PALAVRA **BAHIA**.

COPIE.

Ha - He - Hi - Ho - Hu

Ha - He - Hi - Ho - Hu

ha - he - hi - ho - hu

ha - he - hi - ho - hu

h

H

h h H H



homem	hélice	HUGO
HOSPITAL	humano	hotel
HELLMANN'S	hoje	hora
hoje	haver	helicóptero
HELIOS	hiema	hortelã
HÉLIO	há	

LEIA AS PALAVRAS DO QUADRO, CIRCULE AS SÍLABAS COM A LETRA **H** E COPIE AS PALAVRAS, DE ACORDO COM A INDICAÇÃO DAS SÍLABAS.

HAVIA	HIGIENE	HUGO	HOTEL	HÁLITO
HUMANO	HERÓI	HUMOR	HINO	HÁBITO
HELENA	HOJE	HUMANIDADE	HÉLICE	HEPATITE
HISTÓRIA	HOSPITAL	HIENA	HARPA	HORTA

HA	HE	HI

HO	HU

COMPLETE AS PALAVRAS COM A LETRA INICIAL ADEQUADA.

___GREJA	___OJE	___LHA
___UMANIDADE	___UMANO	
___ÉLICE	___OSPITAL	___ORA
___UMOR	___EPATITE	
___ABILITAÇÃO	___ORROR	___OMEM

a q u b A C S z m X N O p c G V

DESCUBRA O SEGREDO E LIGUE AS PALAVRAS.

HÉLICE

UM

HOJE

ARMÁRIO

HINO

HORA

HOMEM

ILHA

HÁBITO

ESTUDO

HUMANO

COPIE AS PALAVRAS QUE VOCÊ LIGOU E SEPRE-AS EM SILABAS.

Grid for copying and syllabifying the word 'HORA'.

Grid for copying and syllabifying the word 'HORA'.

Grid for copying and syllabifying the word 'HORA'.

Grid for copying and syllabifying the word 'HORA'.

Grid for copying and syllabifying the word 'HORA'.

Grid for copying and syllabifying the word 'HORA'.

FORME PALAVRAS COM AS SÍLABAS DAS FICHAS.

Syllable cards: HIS, TO, RIA

Syllable cards: MA, HU, NO

Syllable cards: HO, O, RÁ, RI

Syllable cards: TI, PA, HE, TE

Syllable cards: BI, TO, HÁ

Syllable cards: HI, NA, E

Syllable cards: HE, LI, CE

Syllable cards: RAS, HA

C b v h a B q A C u z m O X

CIRCULE E COPIE AS PALAVRAS, DE ACORDO COM OS DESENHOS CORRESPONDENTES.

ILHA  
HINO  
HIPOPÓTAMO  
HISTÓRIA



HOMEM  
HORA  
OSTRA  
HOJE



HÉLICE  
ERVILHA  
HELENA  
HERA



IGREJA  
HIPOPÓTAMO  
HINÁRIO  
HIENA



HORA  
HOJE  
HORÁRIO  
HOSPITAL



HIGIENE  
HIENA  
HINO  
HISTÓRIA



LIGUE AS SÍLABAS FORMANDO PALAVRAS.

HA	BI	TA	_____	HE	LI	CE	_____
	LI	TO	_____		RA	_____	
	RAS	_____	_____		XA	_____	
							_____
							_____
							_____
HO	JE	_____	HU	GO	_____		
	MEM	_____		MO	_____		
	TEL	_____		MA	NO	_____	
RA	_____						_____

COMPLETE O TEXTO COM AS PALAVRAS QUE FALTAM.

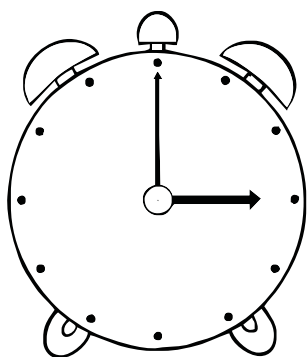

O RELÓGIO MARCA A \_\_\_\_\_.

HÁ \_\_\_\_\_ PARA TUDO.

\_\_\_\_\_ DE ESTUDAR,

\_\_\_\_\_ DE COMER,

\_\_\_\_\_ DE BRINCAR,

\_\_\_\_\_ DE PASSEAR,

\_\_\_\_\_ DE DORMIR.

LEIA AS PALAVRAS E COMPLETE  
A HISTÓRIA SOBRE HELENA E HEITOR.

HOJE	HINO	HEITOR
HELENA	HUMANO	HISTÓRIA

\_\_\_\_\_ E \_\_\_\_\_ TAMBÉM ESTÃO NA MESMA ESCOLA.

NA ENTRADA, TODOS CANTARAM O \_\_\_\_\_ NACIONAL.

\_\_\_\_\_, ELES ESTUDARAM \_\_\_\_\_.

\_\_\_\_\_ E \_\_\_\_\_ ESTÃO ESTUDANDO SOBRE O  
CORPO \_\_\_\_\_.

ELES SÃO ÓTIMOS ALUNOS.

NAS PALAVRAS ABAIXO, CIRCULE AS  
SÍLABAS COM A LETRA **H** E DEPOIS COPIE-AS.

HORA

HOSPITAL

HAVIA

HISTÓRIA

HELENA

HÉLICE

HIENA

HÁLITO

HUMANO

HABILIDADE

HÉLICE

HIGIENE

COPIE AS FRASES SUBSTITUINDO OS DESENHOS PELAS PALAVRAS.

VI O  NO JARDIM ZOOLOGICO.

PAPAI VIU A  E FOI PARA O TRABALHO.

NAQUELE MURO HÁ MUITA .

HUGO FAZ A  DOS DENTES.

COMPLETE AS FRASES COM A PALAVRA CORRETA.

HISTÓRIA      HUGO      HINO      HAVIA

HELENA CANTA \_\_\_\_\_ DO HINÁRIO.

HORÁRIO      HAVIA      HINO      HERÓI

HEITOR É O \_\_\_\_\_ DA RUA.

HUMO      HORA      HISTÓRIA      HOJE

COLOQUEI \_\_\_\_\_ NO VASO DE BARRO.

HIENA      HERA      HORA      HIGIENE

A \_\_\_\_\_ SUBIU PELO MURO DA ESCOLA.

JUNTE AS SÍLABAS DOS QUADRADINHOS  
E FORME PALAVRAS. PARA CADA PALAVRA  
FORMADA, PINTE-AS EM COR DIFERENTE.

HOR HOS TA HAR HO PI JE TAL PA

HO HI LO HO NO FO TEL TE

FORME PALAVRAS DE ACORDO COM OS NÚMEROS.

1 HO	2 NO	3 HI
4 MEM	5 LO	6 LI
7 HÉ	8 CE	9 TE
10 FO	11 JE	12 RA

1 - 5 - 10 - 9

7 - 6 - 8

1 - 11

1 - 12

1 - 4

3 - 2

LIGUE AS PALAVRAS AOS DESENHOS.

HIENA  
HOTEL  
HIPOPÓTAMO  
HORA  
HELENA  
HARPA  
HÉLICE  
HOMEM  
HINÁRIO  
HOLOFOTE

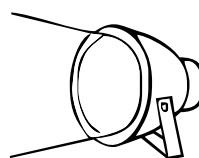
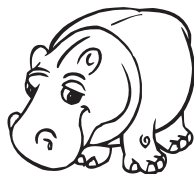
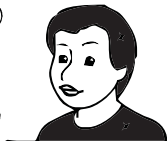
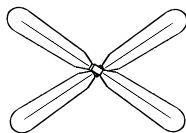
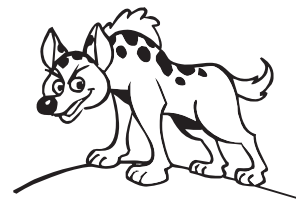
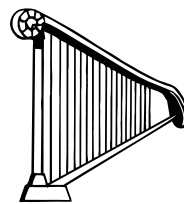

TROQUE A PRIMEIRA LETRA DAS PALAVRAS E ESCREVA OUTRAS PALAVRAS.

HOMEM

\_\_\_OMEM

\_\_\_OMEM

\_\_\_OMEM

HORA

\_\_\_ORA

\_\_\_ORA

\_\_\_ORA

HINO

\_\_\_INO

\_\_\_INO

\_\_\_INO

ESCOLHA UM NOME PARA CADA CRIANÇA.

HEITOR - HILDA - HELENA - HÉLIO - HELOÍSA

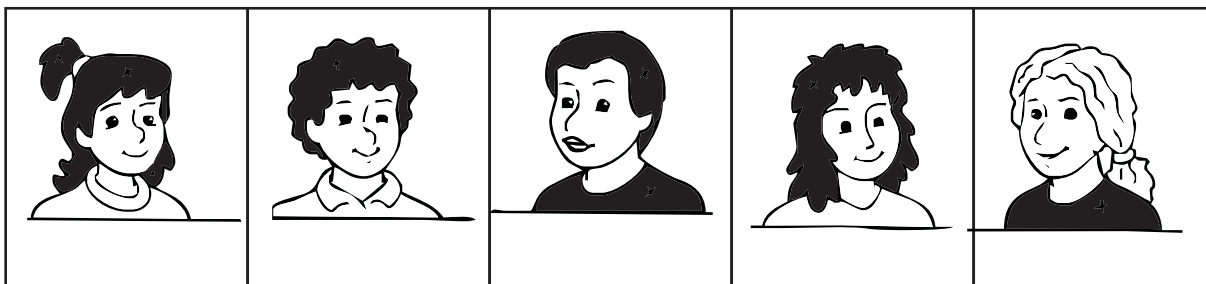

CAÇA - PALAVRAS

Z	X	H	Á	B	I	T	O	K	R
W	H	E	M	A	T	O	M	A	H
K	Á	R	F	J	L	N	R	S	O
C	B	A	G	H	U	M	O	X	R
D	H	A	L	T	E	R	E	Z	Á
H	A	M	B	Ú	R	G	U	E	R
A	R	I	P	V	W	K	Q	Y	I
L	A	Q	H	U	R	R	A	L	O
L	S	H	O	L	O	F	O	T	E

HERA	HALL	HÁ	HEMATOMA
HÁBITO	HORÁRIO	HAMBÚRGUER	HUMO
HALTERE	HARAS	HOLOFOTE	HURRA



a q u b A C S Z m X N O P C G V

**AUTODITADO.**

HEITOR ESTÁ PENSANDO EM PALAVRAS QUE TÊM A LETRA **H**.  
VAMOS AJUDÁ-LO A ESCREVÊ-LAS?

\_\_\_\_\_

\_\_\_\_\_

\_\_\_\_\_

\_\_\_\_\_

\_\_\_\_\_

\_\_\_\_\_



\_\_\_\_\_

\_\_\_\_\_

\_\_\_\_\_

\_\_\_\_\_

\_\_\_\_\_

\_\_\_\_\_

\_\_\_\_\_

\_\_\_\_\_

\_\_\_\_\_

C b v H a B q A C u z m O X

a q u b A C S Z m X N O P C G V

p  
c  
v  
o  
g  
s  
a  
s  
u  
D  
q  
N  
G  
C  
h

g  
a  
S  
U  
q  
h  
Z  
S  
P  
r  
D  
A  
m  
O  
V  
P  
N

É HORA DO DITADO.

PALAVRAS COM  
A LETRA

H

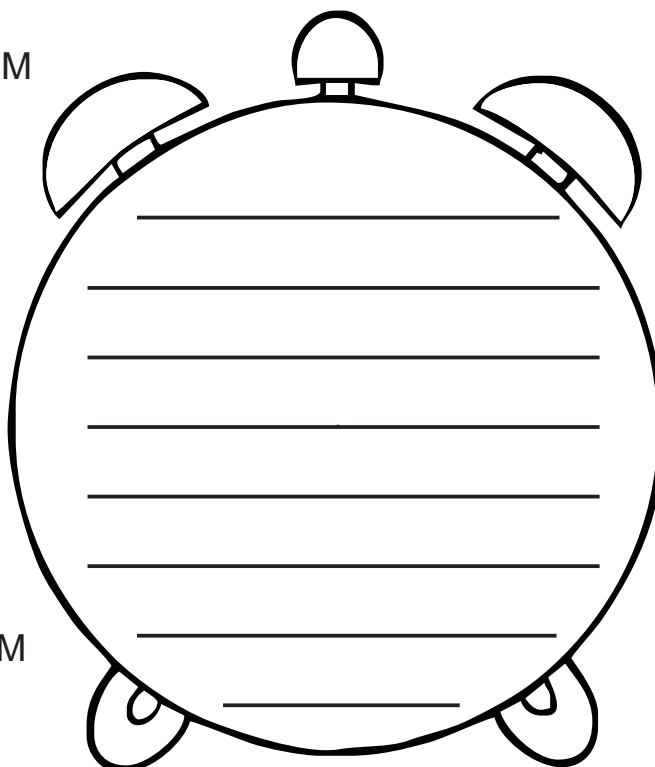

PALAVRAS COM  
A LETRA

A

_____	_____
_____	_____
<div style="border: 1px solid black; padding: 5px; margin: 0 auto; width: 80%;"> <p>_____</p> <p>_____</p> </div>	
_____	_____
_____	_____

C b v H a B q A C u z m O X

### O MEU CHAPÉU

O MEU CHAPÉU TEM TRÊS PONTAS,  
TEM TRÊS PONTAS, O MEU CHAPÉU.  
SE NÃO TIVESSE TRÊS PONTAS,  
NÃO SERIA O MEU CHAPÉU.

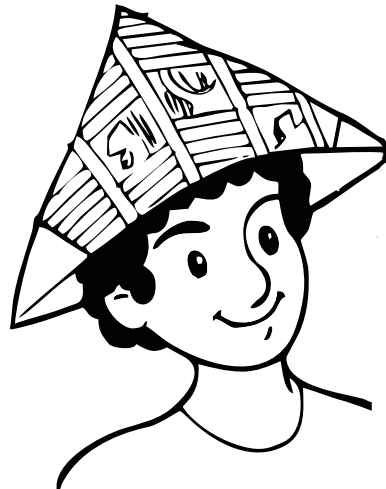

(CD CANTIGAS INFANTIS,  
CIRANDA CULTURAL, pág. 40.)

ASSINALE NO TEXTO A PALAVRA CHAPÉU.

CHAPÉU

chapéu

chapéu

cha-che-chi-cho-chu

Cha-Ché-Chi-Chó-Chu

ch-

Ch-

chave	CHICO
chão	chovê
CHEQUE	chocolate
	MOCHILA
chuveiro	chuchu
CHINA	CHURRASCO
chupeta	chinelô

ch

CH

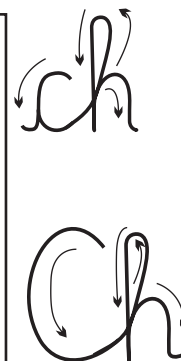

SUBSTITUA OS CÓDIGOS PELAS SÍLABAS  
CORRESPONDENTES E FORME PALAVRAS.

CHA	MA	MO	RO	CO	BO	VA	TE
-----	----	----	----	----	----	----	----

DO	VEI	CHO	CHI	CHU	LA	CHE	QUE
----	-----	-----	-----	-----	----	-----	-----















COMPLETE AS PALAVRAS  
ESCREVENDO SÍLABAS DA FAMÍLIA **CH**.

LAN \_\_\_\_

\_\_\_\_ MINÉ

\_\_\_\_ VA

\_\_\_\_ VEIRO

\_\_\_\_ COLATE

MO \_\_\_\_ LA

CA \_\_\_\_

CHU \_\_\_\_

LAN \_\_\_\_ NETE

\_\_\_\_ VARADA

CO \_\_\_\_ LO

\_\_\_\_ GADA

CA \_\_\_\_ RRO

FE \_\_\_\_ DURA

\_\_\_\_ LEIRA

JUNTE AS SÍLABAS DE ACORDO COM OS NÚMEROS E FORME PALAVRAS.

RA	CHU	LA	DA	CHO	MA	TE	CHA	VE	CO
----	-----	----	----	-----	----	----	-----	----	----

1      2      3      4      5      6      7      8      9      10

5 - 10 - 3 - 7

5 - 9

1 - 8 - 4

2 - 7

\_\_\_\_\_

8 - 9

6 - 8 - 4 - 4

8 - 6

1 - 5

\_\_\_\_\_

8 - 1 - 4

6 - 2 - 10

1 - 8

2 - 3

\_\_\_\_\_

FORME PALAVRAS COM AS SÍLABAS QUE ESTÃO NO DESENHO.

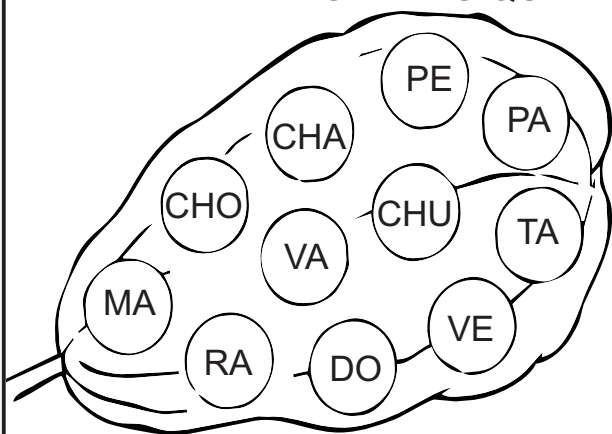

\_\_\_\_\_

\_\_\_\_\_

\_\_\_\_\_

\_\_\_\_\_

ESCREVA PALAVRAS INICIADAS COM AS SÍLABAS INDICADAS ABAIXO.

CHA	CHE	CHI	CHO	CHU



SUBSTITUA OS DESENHOS PELOS  
NOMES E ESCREVA AS FRASES.

A  É DE ALUMÍNIO.

TOMEI SOPA DE  E .

A  DE CHICO FICOU NA .

O BEBÊ DE CHIQUITA CHUPA .

COMPLETE AS FRASES COM A PALAVRA CORRETA.

CAMOMILA CHÁ CHUCHU CHOCOLATE

O RECHEIO DO BOLO É DE \_\_\_\_\_.

CHAMINÉ CHUVEIRO DUCHA

O \_\_\_\_\_ ESTÁ DESLIGADO DA TOMADA.

CHUTEIRA CHAPINHA CHAVE

A \_\_\_\_\_ MACHUCOU O PÉ DO JOGADOR.

CHOROU CHINELADA ACHEI

CHIQUINHO FEZ ARTE E LEVOU UMA \_\_\_\_\_.

CIRCULE AS SÍLABAS NAS PALAVRAS ABAIXO, DE ACORDO COM AS SÍLABAS INICIAIS INDICADAS PELOS DESENHOS.

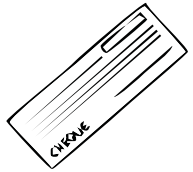
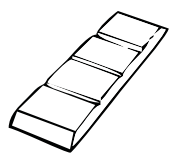
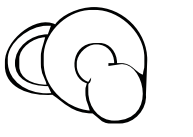
	CHAVE XADREZ	JANELA CHÁCARA	CHAMADA CANETA
	CHEFE JEGUE	QUEIJO CHEGA	CHEIRO SEBO
	CHITA GIRAFA	QUILO CHIQUE	MAXIXE CHICOTE
	JOGO CACHO	CHOCO FOGO	CHOQUE SOCO
	CHUCHU QUATRO	CHUVA LUXO	CHUTE XUXA

LIGUE AS SÍLABAS E FORME PALAVRAS.

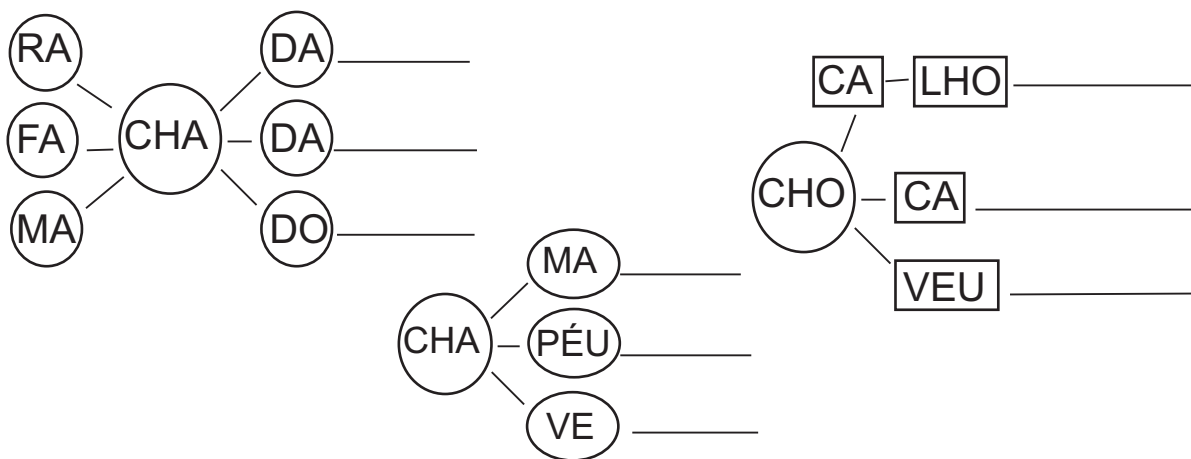



COLOQUE AS PALAVRAS ABAIXO NOS  
RETÂNGULOS, DE ACORDO COM A NUMERAÇÃO.

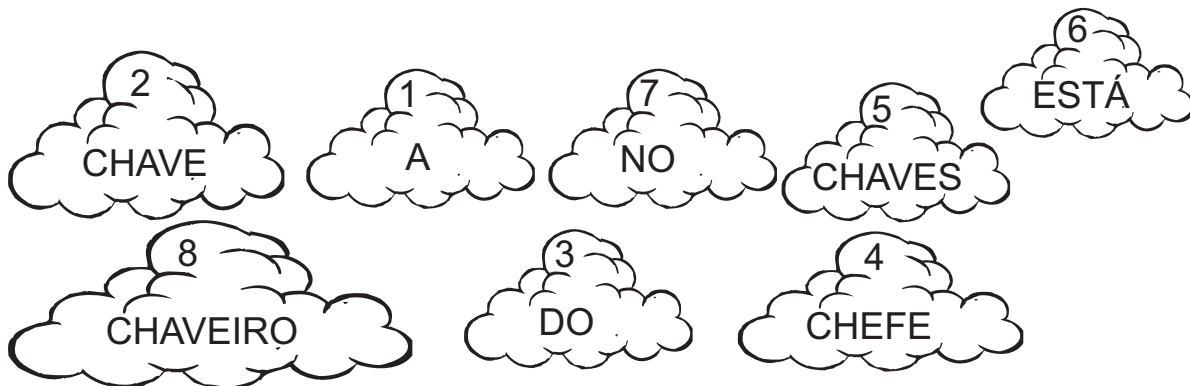

1	2	3	4	5
	6	7	8	

(COLEÇÃO ATIVIDADES DE FOLCLORE, CIRANDA CULTURAL).

COMPLETE O TEXTO COM AS PALAVRAS ABAIXO.

FECHADURA - CHICO - PORTA - CHAVE

\_\_\_\_\_ TEM UMA CHAVE .

ELE COLOCA A \_\_\_\_\_ NA \_\_\_\_\_

E FECHA A \_\_\_\_\_ .

FORME FRASES COM AS PALAVRAS DAS FRASES.

BOLACHA \_\_\_\_\_

CHAVEIRO \_\_\_\_\_

CHUPETA \_\_\_\_\_

CHINELO \_\_\_\_\_

CHOCOLATE \_\_\_\_\_

COLOQUE OS SÍMBOLOS, DE ACORDO COM AS SÍLABAS.

CHA	CHE	CHI	CHO	CHU	CHÃO
●	■	▼	□	■	

CHINELO	<input type="checkbox"/>	CHAPÉU	<input type="checkbox"/>	CHICOTE	<input type="checkbox"/>
CHAVE	<input type="checkbox"/>	CHOCOLATE	<input type="checkbox"/>	CHUVEIRO	<input type="checkbox"/>
CHUPETA	<input type="checkbox"/>	BOLACHA	<input type="checkbox"/>	CACHORRO	<input type="checkbox"/>
SABICHÃO	<input type="checkbox"/>	SALSICHA	<input type="checkbox"/>	SALSICHÃO	<input type="checkbox"/>

ESCREVA AS PALAVRAS NO QUADRO, DE ACORDO COM O NÚMERO DE SÍLABAS.

CACHO				
CACHORRO				
FECHADURA				
CHAPA				
CHEFE				
CACHIMBO				
CHICOTE				
CHUPETA				
CHINELO				
CHINELADA				
CHOCOLATE				
CHÁCARA				

RECORTE AS PALAVRAS DAS FICHAS E  
COLE-AS DE ACORDO COM OS DESENHOS.

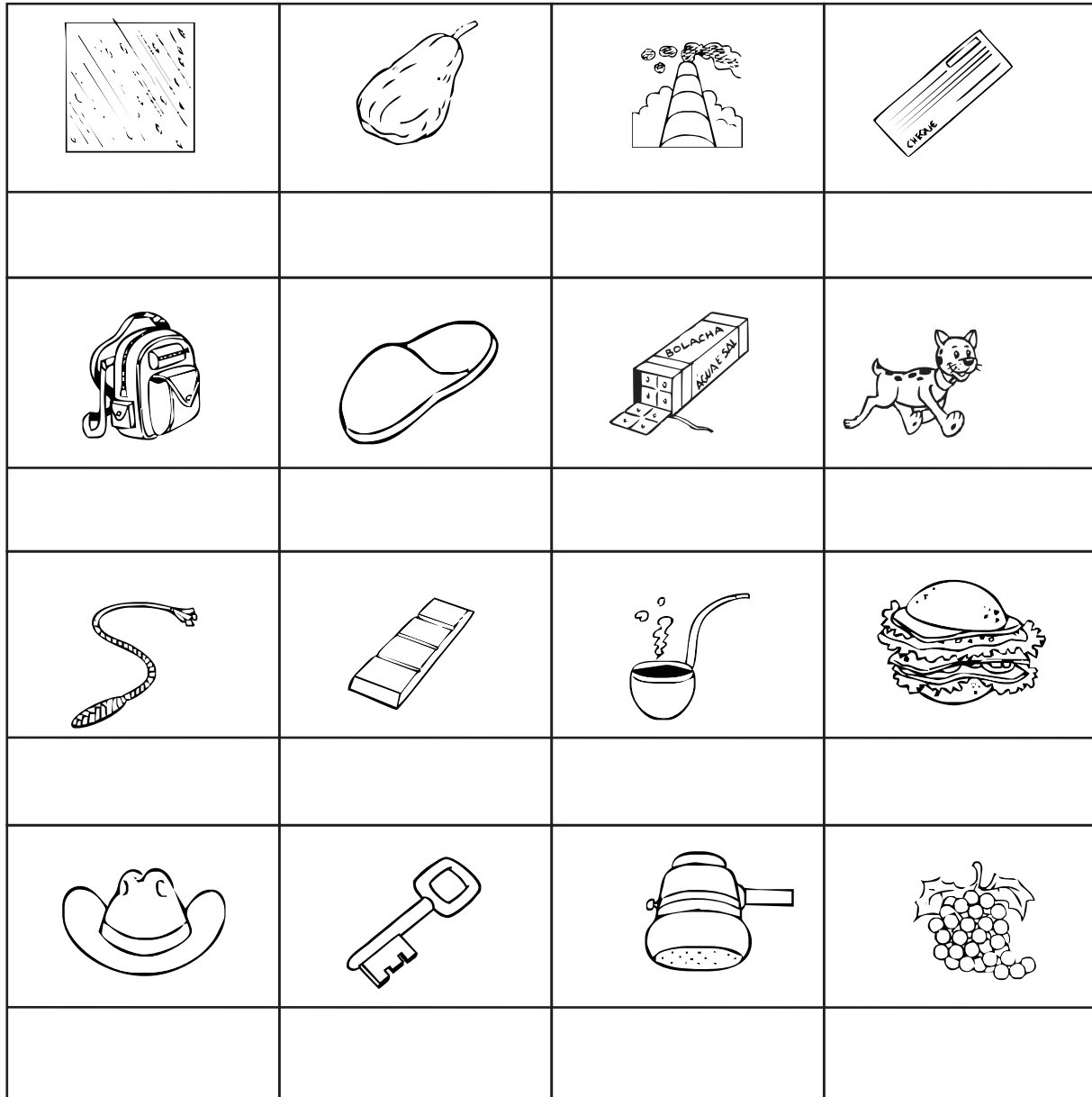

CHAVE	CHUVA	CACHORRO	CHEQUE
BOLACHA	CHINELO	CHAPÉU	CHICOTE
MOCHILA	CHAMINÉ	CHUCHU	LANCHE
CACHO	CHOCOLATE	CACHIMBO	CHUVEIRO

É HORA DO DITADO.

CH

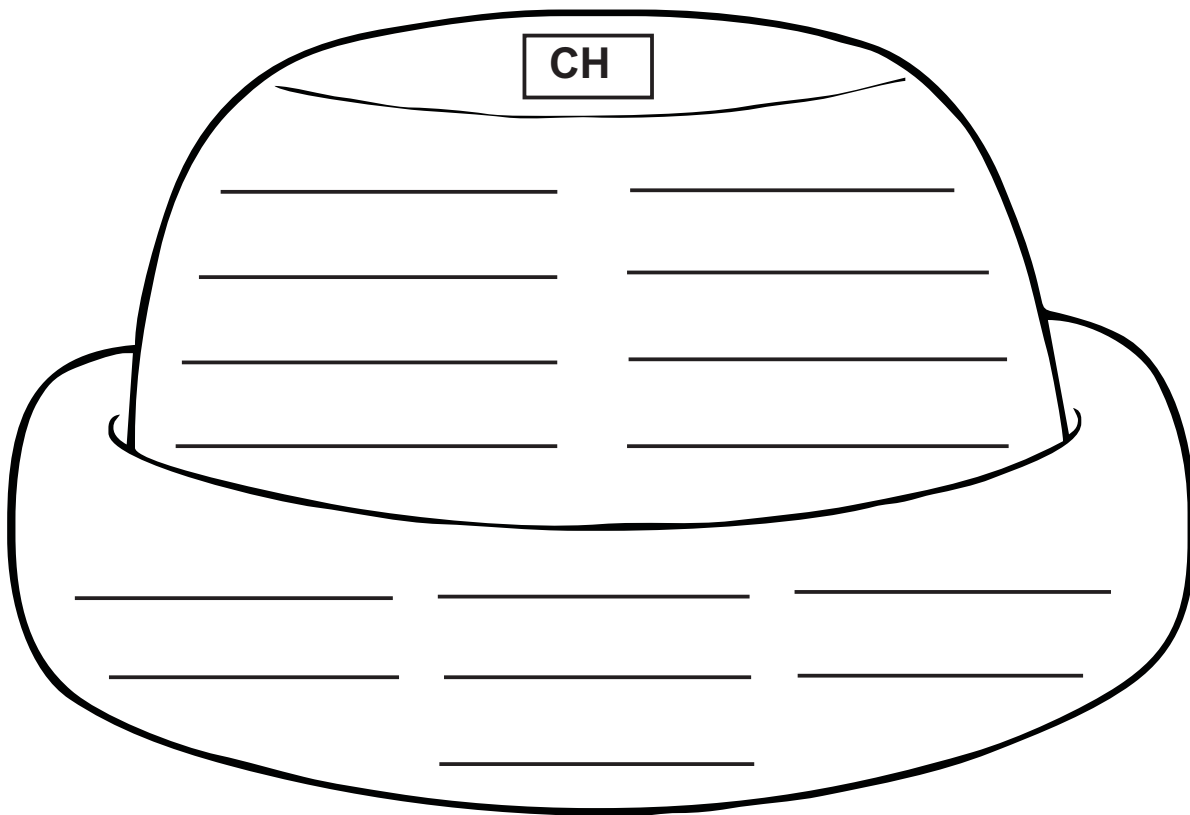

X

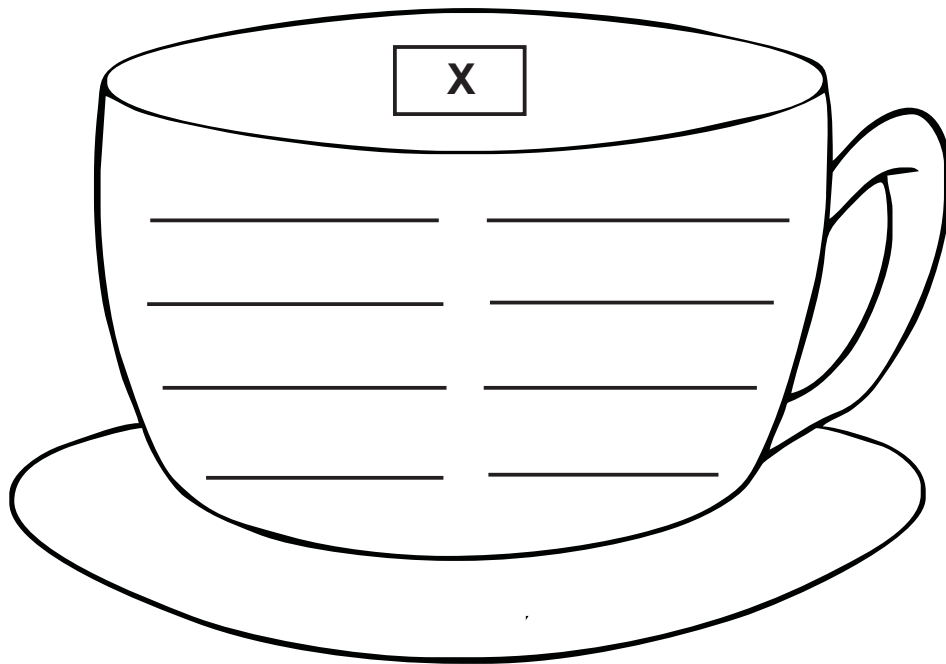

a q u b A C S z m X N O P C G V  
p  
c  
L  
O  
g  
S  
a  
S  
U  
D  
q  
N  
G  
h  
C  
b v h a B q A C u z m O X

### CANÇÃO DO PALHACINHO

BATE PALMA, PALHACINHO  
BATE PALMA SEM PARAR.  
BATE PALMA, PALHACINHO  
PARA O CIRCO ALEGRAR!

TRÁ – LÁ – LÁ...

PULA, PULA, PALHACINHO  
PULA, PULA SEM PARAR.  
PULA, PULA, PALHACINHO  
PARA O CIRCO ALEGRAR!



(CD CANTIGAS INFANTIS, CIRANDA CULTURAL, pág. 53)

CIRCULE NO TEXTO A PALAVRA **PALHACINHO**.

**PALHACINHO**

Iha-lhe-lhi-lho-lhu

Lha-Lhe-Lhi-Lho-Lhu

Iha  
Lha

Ihã  
Lhã

palhaço   filho   olho  
             ilha        espelho  
agulha   lhama   bolha  
             rolha        joelho  
rolha                TELHA  
folha                ALHO        julho

LIGUE OS NOMES AOS DESENHOS E  
DEPOIS SEPRE AS PALAVRAS EM SÍLABAS.



ORELHA

--	--	--

FOLHINHA

--	--	--



MILHO

--	--



COELHO

--	--	--

ALHO

--	--

OLHOS

--	--

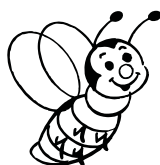
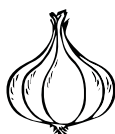

ABELHINHA

--	--	--	--

ORDENE AS SÍLABAS E ESCREVA AS PALAVRAS.

LHO - E - CO

--

LHO - GA

BE - LHA - A

--

GU - LHA - A

--

GA - NHO - LHI

LHO - A

--

LHA - TE - DO

LHI - NHA - FO

--

LHE - BI - TE

--

RE - LHA - O

a q u b A C S z m X N O p c G V

ESCREVA AS PALAVRAS. SIGA O MODELO.

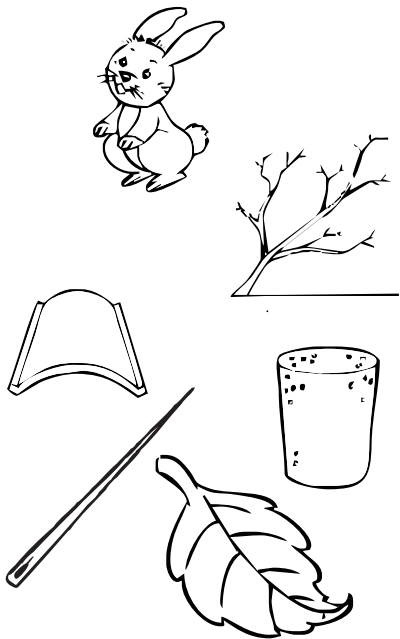

COELHO

COELHINHO

GALHO

\_\_\_\_\_

TELHA

\_\_\_\_\_

ROLHA

\_\_\_\_\_

AGULHA

\_\_\_\_\_

FOLHA

\_\_\_\_\_

LEIA AS PALAVRAS E ESCREVA-AS NOS QUADROS DE ACORDO COM AS SÍLABAS INDICADAS. CIRCULE AS SÍLABAS COM **LH** NAS PALAVRAS.

- ILHA
- ALHO
- BILHETE
- FILHINHO
- OVELHA
- GALHO
- VELHINHO
- ORELHUDO
- MILHO
- RAMALHETE
- JOELHO
- LHAMA
- ABELHUDO

_____	LHA
_____	
_____	

_____	LHE
_____	
_____	

_____	LHI
_____	

_____	LHO
_____	
_____	

_____	LHU
_____	
_____	

C b v h a B q A C u z m O X

SUBSTITUA OS DESENHOS PELOS NOMES  
CORRESPONDENTES E ESCREVA AS FRASES.



O \_\_\_\_\_ ESTÁ NO PICADEIRO.

O NINHO DO \_\_\_\_\_



É DE PALHA DE \_\_\_\_\_



O \_\_\_\_\_



É \_\_\_\_\_



VOVÓ GANHOU UM \_\_\_\_\_



DE ROSAS.

JUNTE AS SÍLABAS E ESCREVA AS PALAVRAS.

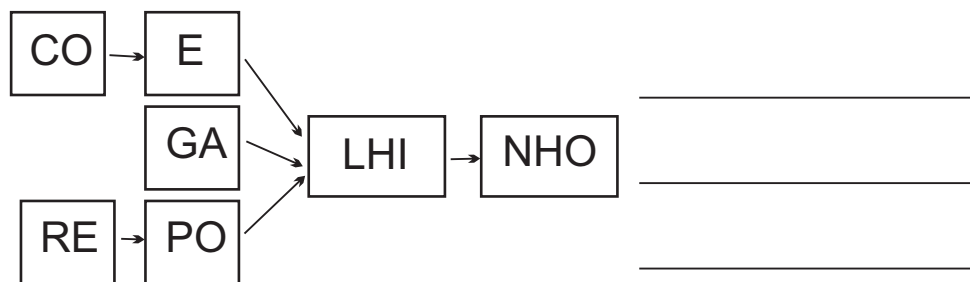
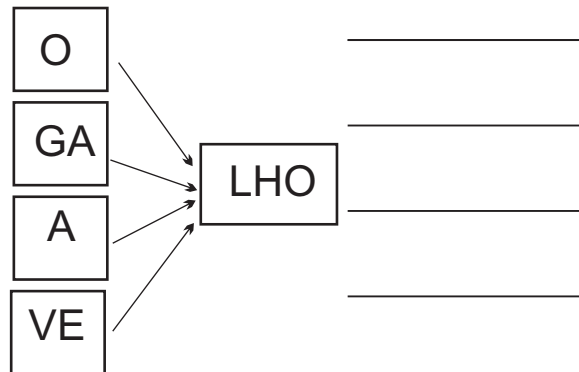
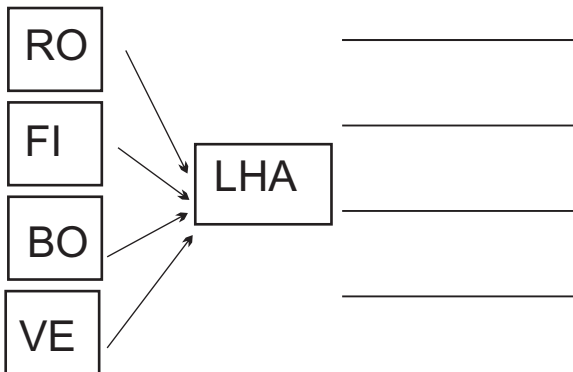

ADIVINHE.  
TEM DENTE, MAS NÃO SE COME; TEM BARBA, MAS NÃO É HOMEM? (ALHO)



LEIA AS PALAVRAS E ESCREVA  
COMPLETANDO AS FRASES.

GARGALHADA - PALHAÇO - VERMELHO - CAMBALHOTA

CAÇULA É O \_\_\_\_\_ DO CIRCO. NO PESCOÇO, ELE  
TEM UM LAÇO \_\_\_\_\_.

CAÇULA DÁ \_\_\_\_\_ E A MENINADA RI DO \_\_\_\_\_.  
A CRIANÇADA SE DIVERTE DANDO MUITA \_\_\_\_\_.

COMPLETE AS PALAVRAS COM  
AS SÍLABAS LHA, LHE LHI, LHO, LHU.

PA_____	CAMBA____TA	OVE_____
GA_____	PA____ÇO	MA_____
BI_____TE	VE_____NHA	COE_____
A_____	ABE_____DO	O_____
_____MA	BI_____TINHO	REPO_____

FORME PALAVRAS, SUBSTITUINDO OS  
NÚMEROS PELAS SÍLABAS CORRESPONDENTES.

1	2	3
FO	PA	TO
4	5	6
TA	LHE	LHA
7	8	9
RO	A	LHO
10	11	12
BA	CA	RA

1 - 6	2 - 6
_____	_____
4 - 6	2 - 5 - 4
_____	_____
1 - 5 - 3	7 - 6
_____	_____
8 - 4 - 9	10 - 12 - 9
_____	_____
11 - 6	12 - 6
_____	_____

ORDENE AS PALAVRAS E ESCREVA AS FRASES.







PALHETA DO É PALHAÇO. A

CHEIO ABELHINHAS ESTÁ O JARDIM DE

QUEBROU. O DA GALHO ÁRVORE

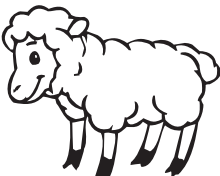
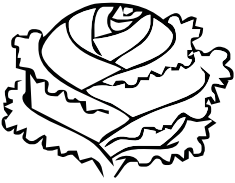
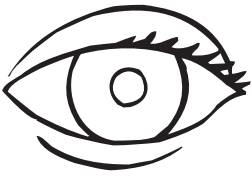
NO ESTÁ O ESPANTALHO MILHARAL.

ESCREVA OS NOMES DOS DESENHOS  
E SEPRE AS PALAVRAS EM SÍLABAS.

OBSERVE AS PALAVRAS E COPIE-AS NO LUGAR ADEQUADO, DE ACORDO COM AS SÍLABAS EM DESTAQUE.

GALHO VELHINHO ESPELHO AGULHA BARULHINHO	LHA	LHE
	ORELHA MILHO COELHO ORELHUDO ORELHÃO OVELHA BILHETE	LHI
LHO	LHU	LHÃO

LEIA AS PALAVRAS E ESCREVA-AS, COMPLETANDO AS EXPRESSÕES.

MILHO	BOLHA	JOELHO	VELHINHO
BILHETE	VERMELHO	PALHAÇO	VELINHA
ESPELHO	OVELHA	ORELHÃO	REPOLHO

\_\_\_\_\_ DE SABÃO  
 \_\_\_\_\_ ENGRAÇADO  
 \_\_\_\_\_ FOFINHA  
 HOMEM \_\_\_\_\_  
 GORRO \_\_\_\_\_  
 \_\_\_\_\_ QUEBRADO

ESPIGA DE \_\_\_\_\_  
 \_\_\_\_\_ DE PORCO  
 SALADA DE \_\_\_\_\_  
 \_\_\_\_\_ DO BOLO  
 \_\_\_\_\_ RASGADO  
 \_\_\_\_\_ QUEBRADO

COMPLETE AS FRASES COM AS PALAVRAS ABAIXO.

MALHADA  
ORELHUDO

PALHA  
COELHA

FILHOTINHO  
MILHO

MALHADA É UMA \_\_\_\_\_.

SEU NINHO É DE \_\_\_\_\_ DE \_\_\_\_\_.

ELA TEM UM \_\_\_\_\_.

SEU FILHOTE É BEM \_\_\_\_\_.

O COELHINHO DE \_\_\_\_\_ É LINDO.

ESCREVA AS PALAVRAS QUE ESTÃO  
REPRESENTADAS POR MEIO DOS DESENHOS,  
CUJAS PALAVRAS TÊM SÍLABAS COM **LH**.

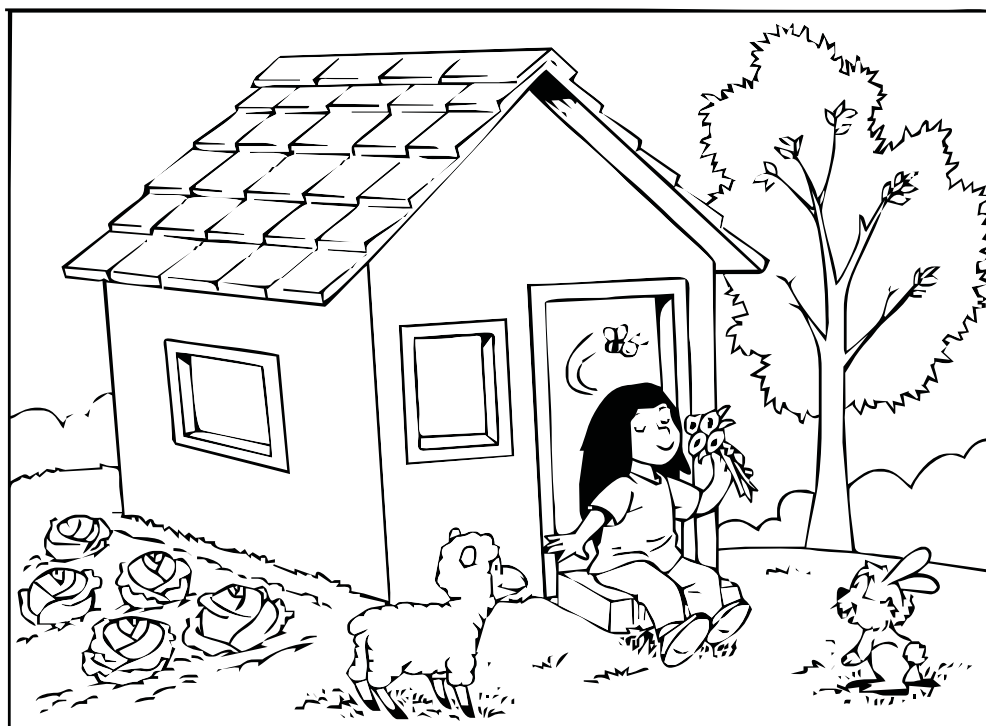

\_\_\_\_\_

a q u b A C S Z m X N O P C G V

JUNTE AS SÍLABAS E FORME PALAVRAS  
QUE CONTENHAM SÍLABAS COM **LH**.

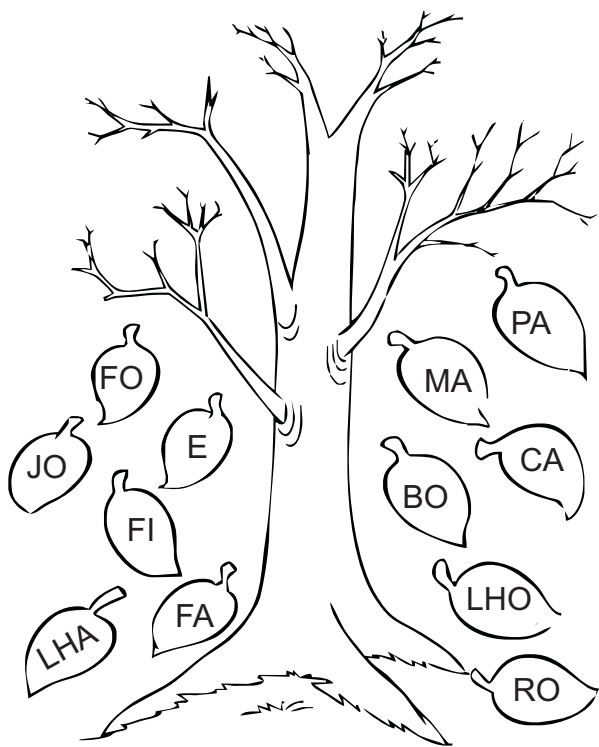

\_\_\_\_\_

\_\_\_\_\_

\_\_\_\_\_

\_\_\_\_\_

\_\_\_\_\_

\_\_\_\_\_

COMPLETE AS PALAVRAS COM **LI** OU **LHI**.

COE \_\_\_\_\_ NHO

CO \_\_\_\_\_ NHA

GA \_\_\_\_\_ NHA

MA \_\_\_\_\_ NHA

JOE \_\_\_\_\_ NHO

ESPE \_\_\_\_\_ NHO

BO \_\_\_\_\_ NHO

BO \_\_\_\_\_ NHO

FO \_\_\_\_\_ NHA

FI \_\_\_\_\_ NHO

ORE \_\_\_\_\_ NHA

FO \_\_\_\_\_ NHA

ESCO \_\_\_\_\_ NHA

CAPE \_\_\_\_\_ NHA

C b v h a B q A C u z m O X

DOMINOX.

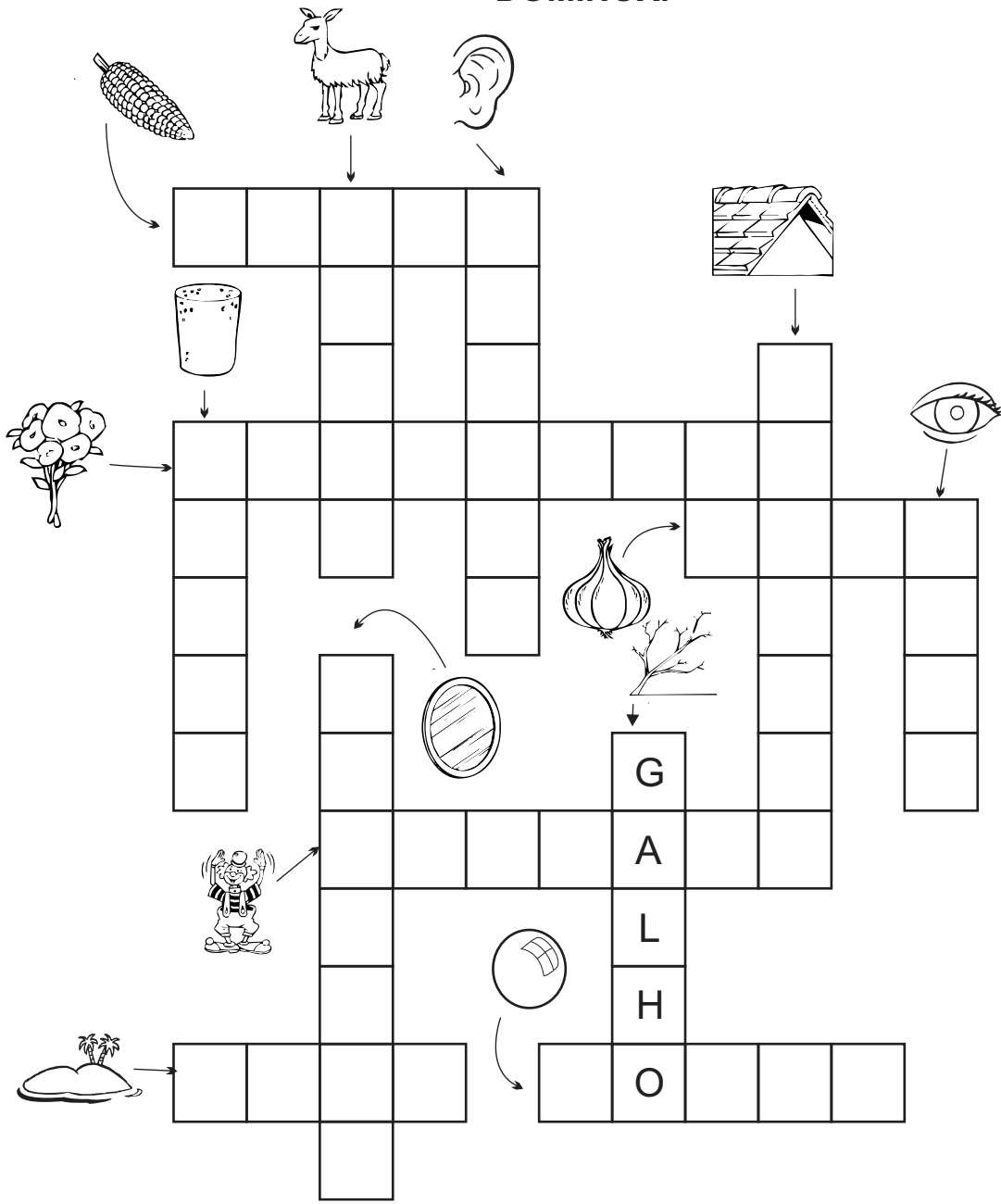

OLHO	MILHO	ORELHA	ILHA
BOLHA	LHAMA	GALHO	TELHADO
ROLHA	RAMALHETE	PALHAÇO	ESPELHO
ALHO			

CAÇA-PALAVRAS SILÁBICO.

MA	A	ME	FE	SE	RE	CI	SA
JU	LHO	RA	ZU	BU	PO	TE	CE
CA	NE	MA	ES	PE	LHO	A	TI
FU	BI	LHE	TE	SU	CU	BE	MI
DA	PA	TE	QUE	O	RE	LHU	DO
BO	LHA	VA	TI	FA	ZI	DO	CI
MA	ÇO	PE	XU	CO	PA	PU	CA
VE	LHI	CE	ZE	E	BU	FO	LHA
NA	QUI	O	RE	LHI	NHA	ÇO	ZA
XO	SI	BU	QUA	NHO	ÇU	FI	ZI

REPOLHO	ORELHUDO	ALHO
BILHETE	JULHO	ESPELHO
BOLHA	VELHICE	ORELHINHA
COELHINHO	PALHAÇO	ABELHUDO
FOLHA	RAMALHETE	CALHA

a q u b A C S Z m X N O P C G V

ESCREVA PALAVRAS QUE  
TENHAM SÍLABAS COM **LH**.

Blank circles with horizontal lines for writing words.



C b v H a B q A C u z m O X



a q u b A C S z m X N O p c G V

É HORA DO DITADO.

PRESTE ATENÇÃO E ESCREVA AS PALAVRAS, DE ACORDO COM AS SÍLABAS INDICADAS.

LH

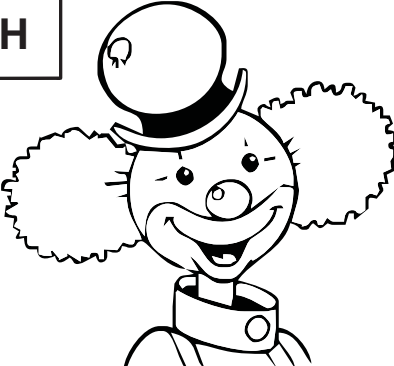

---



---



---



---



---



---



---



---

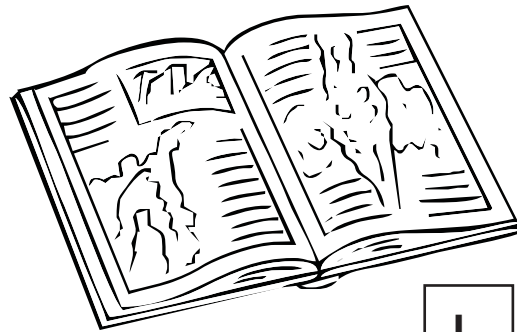

L

---



---



---



---



---



---



---



---

C b v H a B q A C u z m O X

## A GALINHA DO VIZINHO

A GALINHA DO VIZINHO  
BOTA OVO AMARELINHO.  
BOTA 1, BOTA 2, BOTA 3,  
BOTA 4, BOTA 5, BOTA 6,  
BOTA 7, BOTA 8, BOTA 9,  
BOTA 10.



CD CANTIGAS INFANTIS,  
CIRANDA CULTURAL, pág. 141.)

CIRCULE NO TEXTO DA CANTIGA  
AS PALAVRAS QUE TÊM **NH**.

COPIE AS PALAVRAS QUE VOCÊ CIRCULOU.

--	--	--

COPIE.

nha - nhe - nhi - nho - nhu

nha - nhe - nhi - nho - nhu

**NHA - NHE - NHI - NHO - NHU**

nha - nhe - nhi - nho - nhu

unha

aranha

ZEZINHO

sonho

minha

NINHO

nhoque

rainha

sardinha

PINHO

apanha

comunhão

ANINHA

nha

nha

Nha

Nha

nha nhe nhi

nho nhu

## LADAINHA

SALADA, SALADINHA  
FEIJÃO COM PIMENTA  
NA HORA DA JANTA,  
NÃO TEM QUEM AGUENTA!

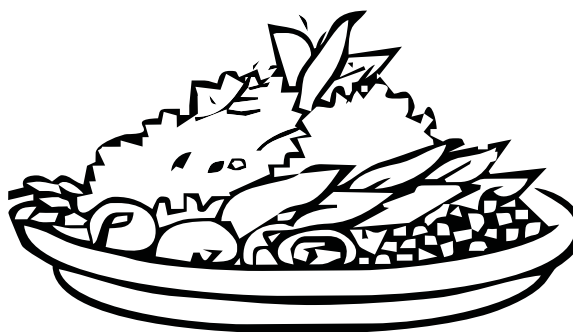

SALADA, SALADINHA  
BEM TEMPERADINHA  
SAL, PIMENTA, SALSA, CEBOLINHA,  
É UM, É DOIS, É TRÊS!

DOMÍNIO PÚBLICO

CIRCULE NO TEXTO, AS PALAVRAS QUE TÊM **NH**.  
DEPOIS, ESCREVA-AS NAS FICHAS E SEPRE AS SÍLABAS.



banho	caminhão
COZINHA	NINHO
SENINHA	BANHEIRO
dinheiro	pamonha

nh	nh
NH	Nh

Nha Nhe Nhi  
Nho Nhu

LIGUE AS SÍLABAS E FORME PALAVRAS.

SO \_\_\_\_\_

LI → NHA \_\_\_\_\_

MI → NHA \_\_\_\_\_

MA → NHA \_\_\_\_\_

VI → NHE → DO \_\_\_\_\_

MU → NHE → CA \_\_\_\_\_

A → RA → NHI → NHA \_\_\_\_\_

VI → NHO \_\_\_\_\_

BA → NHO \_\_\_\_\_

SO → NHO \_\_\_\_\_

TE → NHO \_\_\_\_\_

NE → NHU → MA \_\_\_\_\_

NUMERE OS DESENHOS DE ACORDO COM AS PALAVRAS.

- 1 LINHA
- 2 ARANHA
- 3 GALINHA
- 4 SARDINHA
- 5 MINHOCA
- 6 NINHO
- 7 RAINHA
- 8 VINHO
- 9 PIRANHA
- 10 PAMONHA
- 11 LENHA
- 12 CEGONHA

LIGUE OS NOMES AOS DESENHOS. DEPOIS,  
ESCREVA E SEPRE AS PALAVRAS EM SÍLABAS.



VINHO		
SARDINHA		
MINHOCA		
GAFANHOTO		
PINHEIRO		
ARANHA		
NINHO		
GALINHA		

ESCREVA AS PALAVRAS NO DOMINOX,  
PORÉM SEPARANDO-AS EM SÍLABAS.

- ARANHA
- NINHO
- GATINHO
- MINHOCA
- SARDINHA
- PAMONHA
- NENHUM
- GAFANHOTO
- CAMINHÃO
- NHOQUE

LEIA E COPIE AS PALAVRAS  
DE ACORDO COM A SÍLABA **NH**.

GALINHA	BANHISTA	ARIRANHA	DINHEIRO
NINHO	LENHA	MÃEZINHA	COZINHA
BANHEIRO	NENHUM	SAPINHO	MOINHO
DESENHISTA	PINHEIRO	NENHUMA	VINHO

	NHA		NHE		NHI
_____		_____		_____	
_____		_____		_____	
_____		_____		_____	
_____		_____		_____	

	NHO		NHU
_____		_____	
_____		_____	
_____		_____	
_____		_____	

FAÇA COMO O MODELO E  
CIRCULE A SÍLABA QUE TEM **NH**.

BOLA - BOLINHA

LATA - LATINHA

PATO \_\_\_\_\_

COPO \_\_\_\_\_

GATO \_\_\_\_\_

SAPO \_\_\_\_\_

CACHORRO \_\_\_\_\_

JANELA \_\_\_\_\_

RATO \_\_\_\_\_

BOLO \_\_\_\_\_

AMARELO \_\_\_\_\_

MÃO \_\_\_\_\_

CASA \_\_\_\_\_

CÃO \_\_\_\_\_

CESTA \_\_\_\_\_

MEIA \_\_\_\_\_

PEIXE \_\_\_\_\_

MINHOCA \_\_\_\_\_

DESCUBRA O SEGREDO E  
ESCREVA OUTRAS PALAVRAS.

ARANHA  
APANHA  
ARRANHA

---



---

SONHO  
NINHO  
BANHO

---



---

COELHINHO  
GATINHO  
PATINHO

---



---

CONHECEU  
AMANHECEU

---



---

NENHUM

---



---





COMUNHÃO

---



---

CIRCULE NAS PALAVRAS ABAIXO  
AS SÍLABAS FORMADAS COM **NH**.

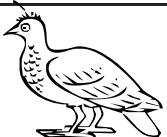
	ARANHA    RAINHA    PINHA    SARDINHA
	BANHEIRO    PINHEIRO    GALINHEIRO    COZINHEIRA
	BANHISTA    ARANHINHA
	NINHO    PINHO    LINHO    GAFANHOTO
	NENHUM    NENHUMA

COMPLETE AS EXPRESSÕES COM AS PALAVRAS ABAIXO.

BANHO - PAMONHA - CAMINHÃO - MOINHO - PINHÃO  
ARANHA - FARINHA - VINHO - SONHO - MANHÃ  
PINHEIRO - GALINHA - CAMINHO - CANHOTO - BANHA

TEIA DE \_\_\_\_\_ BAÚ  
\_\_\_\_\_ DOCE \_\_\_\_\_ DE PORCO  
\_\_\_\_\_ ESTRANHO TOALHA DE \_\_\_\_\_  
\_\_\_\_\_ DE VENTO \_\_\_\_\_ DE TRIGO  
\_\_\_\_\_ DE SOL \_\_\_\_\_ TINTO  
\_\_\_\_\_ DE NATAL \_\_\_\_\_ COZIDO  
ALUNO \_\_\_\_\_ CURTO  
\_\_\_\_\_ CARIJÓ

COMPLETE AS FRASES  
ESCREVENDO AS PALAVRAS DA FICHA.

ANDORINHA - GALINHA - FARINHA - PAMONHA - PINHEIRO  
COZINHEIRA - PIRANHA - LINHA - NINHO - BOLINHA

EU QUEIMEI A LENHA DO \_\_\_\_\_.  
A \_\_\_\_\_ É FEITA DE MILHO.  
ZEZINHO JOGA \_\_\_\_\_ DE GUDE.  
O SANHAÇO SAIU DO \_\_\_\_\_.  
A \_\_\_\_\_ É UMA AVE.  
A \_\_\_\_\_ É UM PEIXE VORAZ.  
A \_\_\_\_\_ SAIU DA AGULHA.  
O PATO SURROU A \_\_\_\_\_.  
A \_\_\_\_\_ COLOCOU \_\_\_\_\_ NO FEIJÃO.



PINTE AS SÍLABAS QUE CORRESPONDEM AOS DESENHOS E ESCREVA AS PALAVRAS.

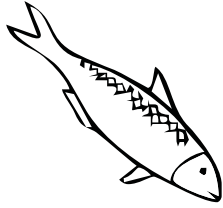

SAR | PI | DI | NHA



MI | NINHA | NHO



CA | MI | PI | NHÃO



MI | NHO | NO | CA

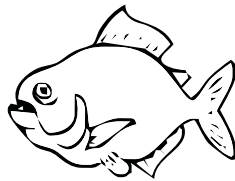

BI | PI | RA | NHA



GA | TI | LI | NHA



PA | MO | TO | NHA

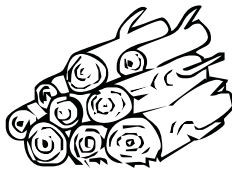

LE | MENHA | NHO



PI | NHEI | SO | RO

COPIE E SEPRE AS SÍLABAS DAS PALAVRAS.

NINHO	LENHA	GATINHA	MINHOCA

COZINHA	MUNHECA	SARDINHA	NHOQUE



SIGA O MODELO.

GALO	GALINHO	GA - LI - NHO
BOLA	_____	_____
PATO	_____	_____
MALA	_____	_____
JANELA	_____	_____
SAPO	_____	_____
FOFO	_____	_____
GATO	_____	_____

COMPLETE AS FRASES COM  
AS PALAVRAS ABAIXO.

FOFINHO ZEZINHO CAIXA PATINHO MINHOCA

\_\_\_\_\_ É O NOME DO MEU AMIGO.







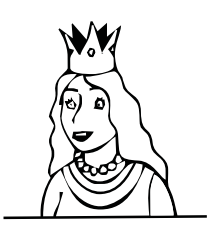
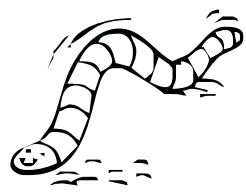
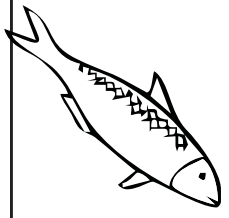
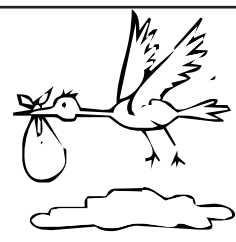

ELE PEDIU UMA \_\_\_\_\_ AO SE PAI.

NA CAIXA COLOCOU O \_\_\_\_\_.

O PATINHO É \_\_\_\_\_.

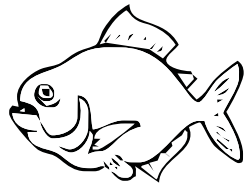
ZEZINHO DEU \_\_\_\_\_ PARA O PATINHO COMER.

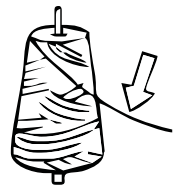
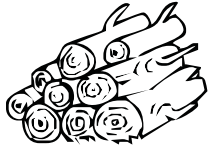
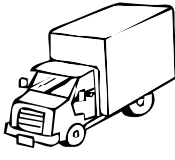
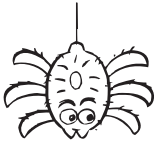
RECORTE AS PALAVRAS DAS FICHAS E  
COLE-AS, DE ACORDO COM OS DESENHOS.

PIRANHA	MINHOCA	PAMONHA	GALINHA
LENHA	NINHO	ARANHA	LINHA
RAINHA	PINHEIRO	FARINHA	DINHEIRO
VINHO	CEGONHA	CAMINHÃO	SARDINHA

a q u b A C S z m X N O p c G V

FORME PALAVRAS JUNTANDO AS SÍLABAS DO DESENHO.

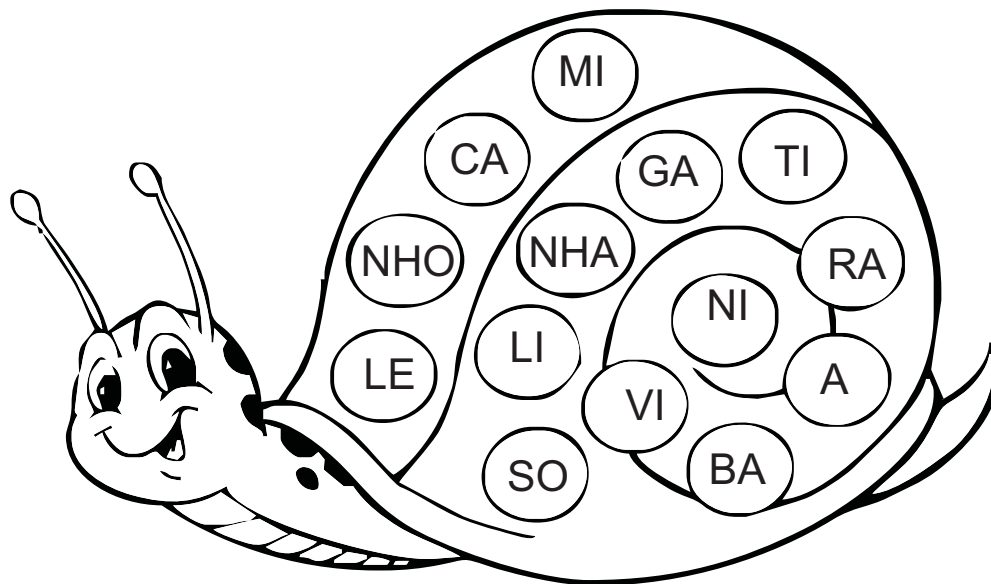

_____	_____	_____
_____	_____	_____
_____	_____	_____
_____	_____	_____

CAÇA-PALAVRAS SILÁBICO.

BA	NO	CO	SO	VI	CA
XO	GA	BE	NI	NHO	MI
CU	LI	QUI	XE	PI	NHÃO
LI	NHA	KA	DI	XU	A
BI	MI	BA	NHEI	RO	RA
SO	NHO	VE	RO	BA	NHA
BU	CA	ZE	BO	GU	TU

- PINHÃO
- LINHA
- SONHO
- VINHO
- BANHEIRO
- GALINHA
- ARANHA
- MINHOCA
- NINHO
- CAMINHÃO
- DINHEIRO
- BANHA

C b v h a B q A C u z m O X

AUTODITADO.

ESCREVA PALAVRAS QUE TENHAM SÍLABAS COM **NH**.

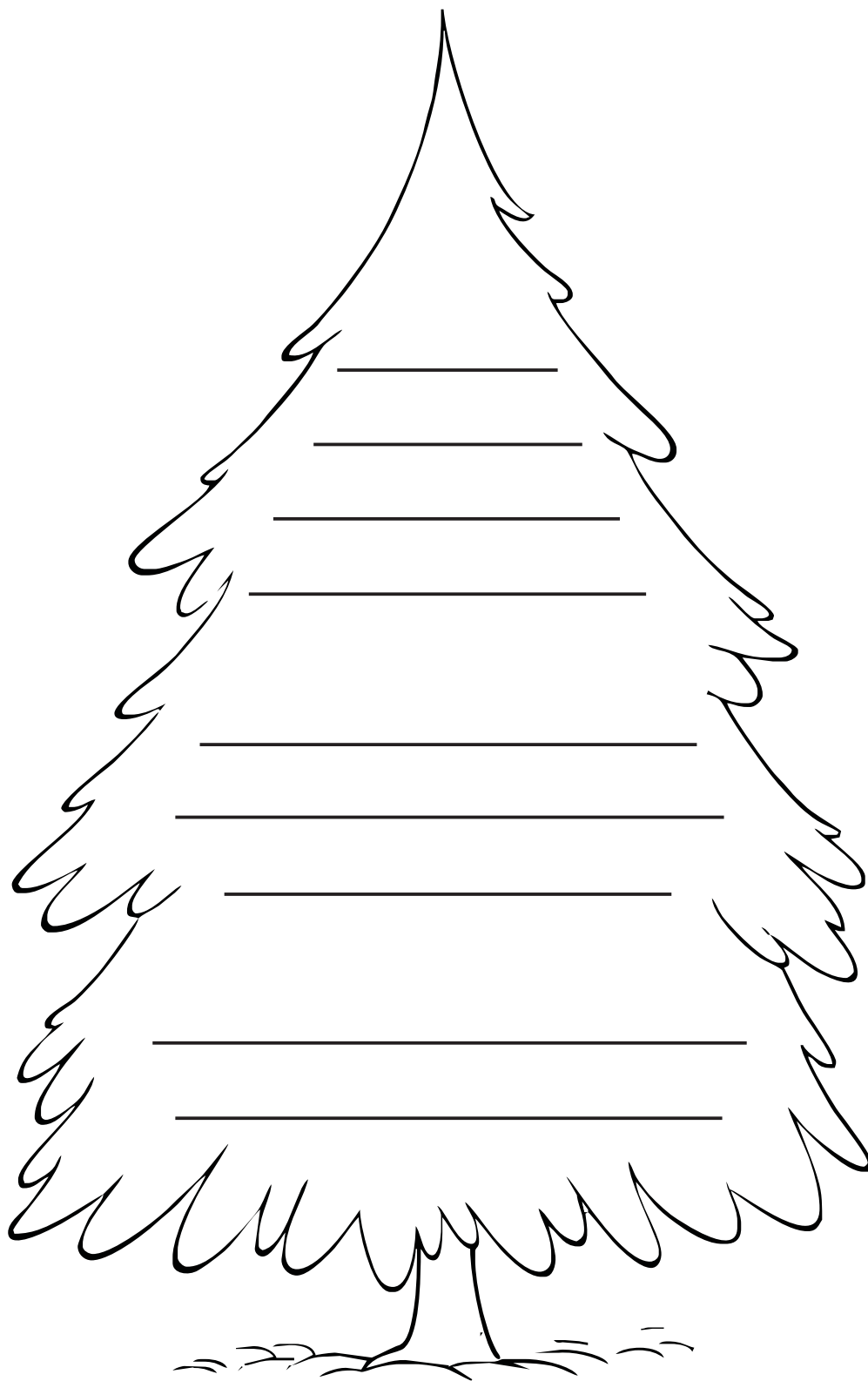

a q u b A C S z m X N O p c G V

É HORA DO DITADO.

VAMOS VER QUEM APRENDEU?

C b v H a B q A C u z m O X

## CAI, CAI, BALÃO

CAI, CAI, BALÃO,  
CAI, CAI, BALÃO,  
AQUI NA MINHA MÃO,  
NÃO CAI NÃO,  
NÃO CAI NÃO,  
NÃO CAI NÃO,  
CAI NA RUA DO SABÃO

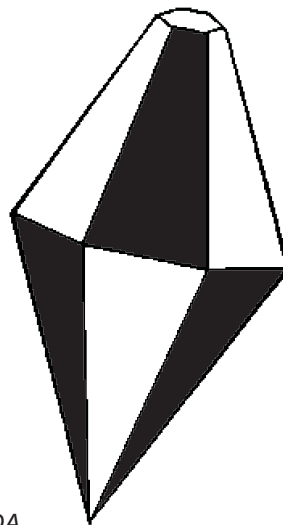

AS MAIS BELAS CANTIGAS DE RODA,  
ED. CIRANDA CULTURAL, PÁG. 5

CIRCULE E COPIE DO TEXTO AS  
PALAVRAS QUE TERMINAM COM **ÃO**.

--	--	--	--

LEIA AS PALAVRAS.

BALÃO	MÃES	RÃS	TALÕES	CAMPEÃO	RÃ
LÃS	LEITÕES	MÃOS	MÃO	AVELÃ	PÃO
MÃE	LÃ	TALÃO	IRMÃS	AVELÃS	
LEITÃO	IRMÃ	BALÕES	PÃES	CAMPEÕES	

CIRCULE AS SÍLABAS QUE FORMAM O FINAL DAS PALAVRAS.  
OBSERVE QUE ELAS TERMINAN EM:

**ÃO**   **ÕES**   **Ã**   **ÃS**   **ÃE**   **ÃES**

LIGUE AS PALAVRAS QUE FAZEM  
PARES E DEPOIS COPIE-AS ABAIXO:





COMPLETE DE ACORDO COM O MODELO.

O PIÃO	OS PIÕES	<span>ÃO</span> ões	O BOTÃO	OS BOTÕES
O BALÃO	OS _____	<span>ÕES</span> ões	O LEÃO	OS _____
O FOGÃO	OS _____		O LEITÃO	OS _____
O MAMÃO	OS _____		O LIMÃO	OS _____
O CORAÇÃO	OS _____		O AVIÃO	OS _____
O VIOLÃO	OS _____		O PILÃO	OS _____
O CAMINHÃO	OS _____		O PORTÃO	OS _____
O ANÃO	OS _____		O CAMARÃO	OS _____

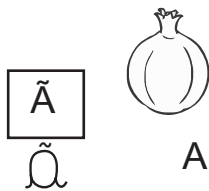

UM PÃO	DOIS PÃES	A MÃO	AS MÃOS
UM CÃO	DOIS _____	O IRMÃO	OS _____
UM CAPITÃO	DOIS _____	O ÓRGÃO	OS _____
		O ÓRFÃO	OS _____





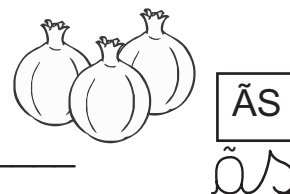







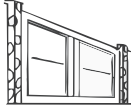

- A FÃ
- A IRMÃ
- A MAÇÃ
- A MANHÃ
- A ANÃ
- A RÃ
- A LÃ



- AS \_\_\_\_\_
- AS \_\_\_\_\_
- AS \_\_\_\_\_
- AS \_\_\_\_\_
- AS \_\_\_\_\_
- AS \_\_\_\_\_
- AS \_\_\_\_\_

LEIA OS NOMES DOS DESENHOS  
E LIGUE O DESENHO À PALAVRA CORRESPONDENTE.

FOGÃO				VIOLÃO
BALÃO				LIMÃO
PIMENTÃO				AVIÃO
PORTÃO				PIÃO
CAMINHÃO				LEÃO
LAMPIÃO				FEIJÃO

FORME FRASES COM AS PALAVRAS ABAIXO.

PERDIGÃO	_____
PARMESÃO	_____
ALMEIRÃO	_____
CAMARÃO	_____
ROJÃO	_____
SABÃO	_____

FAÇA COMO O MODELO.

FACA	FACÃO	SALA	_____
DEDO	_____	PORTA	_____
CANECA	_____	BOLO	_____
LIVRO	_____	TIJOLO	_____
MENINO	_____	GRANDE	_____
CADEIRA	_____	BICHO	_____
VIOLA	_____	GATO	_____

COMPLETE AS FRASES COM AS PALAVRAS DO QUADRO.

MAMÃO RÃS SABÃO HORTELÃ PORTÃO  
VIOLÃO AVIÕES INJEÇÃO PIÕES FEIJÃO

EU COMI \_\_\_\_\_ MUITO GOSTOSO.

EU COMI UM \_\_\_\_\_ MUITO GOSTOSO

VOVÓ GOSTA DE CHÁ DE \_\_\_\_\_.

OS \_\_\_\_\_ TRANSPORTAM PASSAGEIROS.

O \_\_\_\_\_ ESTÁ FECHADO.

AS \_\_\_\_\_ PULARAM NA ÁGUA DA LAGOA.

RENATO TEM VÁRIOS \_\_\_\_\_ PARA BRINCAR.

ROBERTO COMPÕE, CANTA E TOCA \_\_\_\_\_.

EU LAVEI AS MÃOS COM ÁGUA E \_\_\_\_\_.

BRENDA CHOROU QUANDO TOMOU \_\_\_\_\_.

MAMÃE ESTÁ COZINHANDO \_\_\_\_\_.

**ESCREVA AS PALAVRAS NA COLUNA ADEQUADA, DE ACORDO COM O PLURAL, CORRETO.**

CAPITÃES - PORTÕES - IRMÃS - MÃES - IRMÃOS  
 RÃS - BOTÕES - LADRÕES - CÃES - PÃES - MÃOS  
 LÃS - ORFÃOS - AVELÃS - ÓRGÃOS - CAMPEÕES

ÃOS	ÃES	ÕES	ÃS
_____	_____	_____	_____
_____	_____	_____	_____
_____	_____	_____	_____
_____	_____	_____	_____

COMPLETE AS FRASES COM PALAVRAS DO QUADRO ACIMA.

OS \_\_\_\_\_ CORRERAM ATRÁS DOS \_\_\_\_\_.

EU PERDI OS \_\_\_\_\_ DA MINHA CAMISA.

PAULO LAVOU AS \_\_\_\_\_ ANTES DO LANCHE.

OS \_\_\_\_\_ CELSO E PAULO TRABALHAM NO QUARTEL.

PATRÍCIA E MARIANE SÃO \_\_\_\_\_.

LIGUE AS SÍLABAS FORMANDO PALAVRAS.

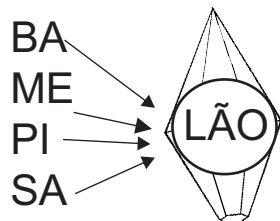

\_\_\_\_\_

\_\_\_\_\_

\_\_\_\_\_

\_\_\_\_\_

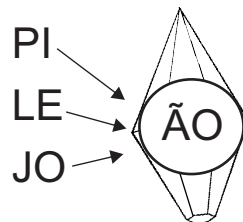

\_\_\_\_\_

\_\_\_\_\_

\_\_\_\_\_

COLOQUE O ACENTO TIL (~) ONDE É NECESSÁRIO.

MAO

PAO

PIAO

TUBARAO

MAMAE

CAO

FOGAO

CAIXAO

MAMAO

RA

BOBAO

MAEZINHA

LAS

SAO

CAPITAES

CAMPEOES

ANAO

ÓRGAO

LEITAO

LEITOES

a q u b A C S z m X N O P C G V  
p  
c  
c  
o  
g  
s  
a  
s  
u  
D  
q  
N  
G  
h  
c  
b v h a B q A C u z m o X

### NA TRIBO ELES VIVEM

NA TRIBO ELES VIVEM,  
COMENDO RAIZ.  
CAÇANDO E PESCANDO,  
GUERREANDO FELIZ.

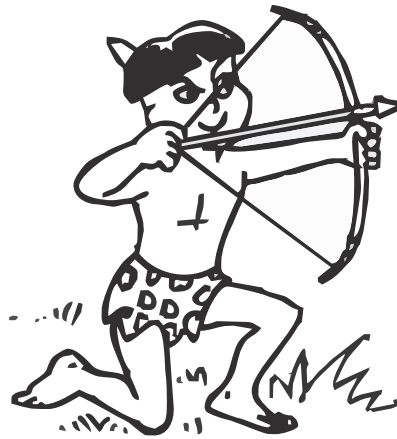

AS MAIS BELAS CANTIGAS DE RODA.  
CIRANDA CULTURAL, pág. 55

CIRCULE NO TEXTO AS PALAVRAS QUE  
TERMINAM COM A LETRA **Z**. DEPOIS, COPIE  
ABAIXO, AS PALAVRAS QUE VOCÊ CIRCULOU.

az - ez - iz - oz - uz

az - ez - iz - oz - uz

**AZ - EZ - IZ - OZ - UZ**

Az Ez Iz Oz Uz

CIRCULE NAS PALAVRAS AS  
SÍLABAS QUE TERMINAM COM **Z**.

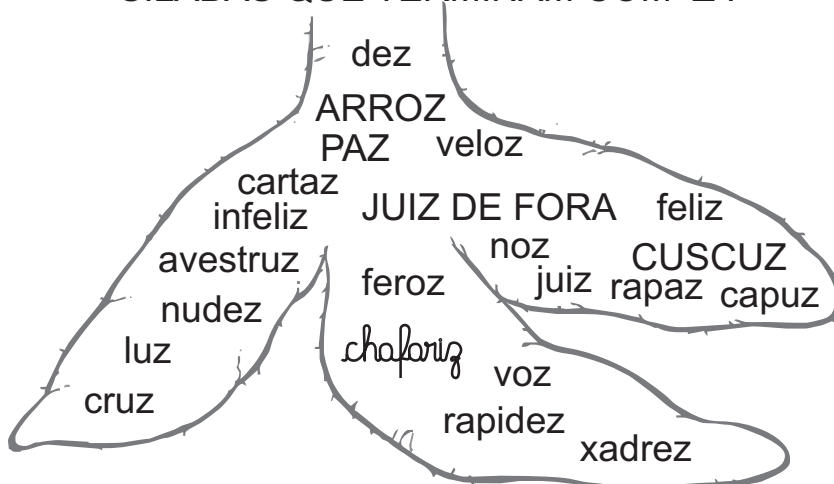

ESCOLHA AS PALAVRAS E COMPLETE AS FRASES.

VELOZ INFELIZ XADREZ NARIZ PERDIZ DEZ

O RAPAÇ FOI \_\_\_\_\_ E QUEBROU O \_\_\_\_\_.

O CAÇADOR NÃO CONSEGUIU CAÇAR A \_\_\_\_\_.

PORQUE ELA FOI MUITO MAIS \_\_\_\_\_.

JULINHO JÁ CONSEGUIU GANHAR \_\_\_\_\_ PARTIDAS DE \_\_\_\_\_.

COMPLETE AS PALAVRAS COM **S** OU **Z**.  
 ESCREVA AO LADO, OUTRAS PALAVRAS QUE  
 TERMINEM EM **AZ** **EZ** **IZ** **OZ** **UZ**.



RAI \_\_\_\_\_



ÔNIBU \_\_\_\_\_



NARI \_\_\_\_\_



LÁPI \_\_\_\_\_

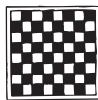

XADRE \_\_\_\_\_



CAPU \_\_\_\_\_



ARRO \_\_\_\_\_



GI \_\_\_\_\_



AVESTRU \_\_\_\_\_

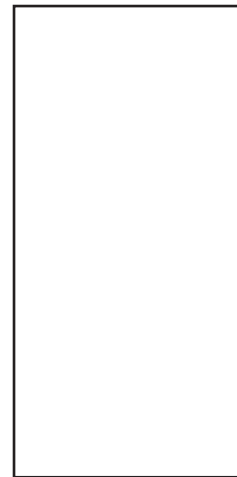

LEIA, SEPRE E JUNTE AS SÍLABAS.

RAPIDEZ		
AVESTRUZ		
INFELIZ		
CAPUZ		
VELOZ		

LEIA AS PALAVRAS DAS FICHAS, COPIE-AS  
NOS QUADROS DE ACORDO COM A INDICAÇÃO.

AZEITE - PAZ - AZEITONA - FAZ - AZEDO  
CAPAZ - FERROZ - BELEZA - GIZ - AMIZADE - DOZE  
AZULEJO - FELIZ - CHAFARIZ - CAPUZ - DEZOITO

ZEBRA

RAPAZ

COMPLETE COM A LETRA **Z** E DEPOIS COPIE  
E SEPRE AS PALAVRAS EM SÍLABAS.

FELI	___

RAI	___

CUSCU	___

CARTA	___

TALVE	___

CAPU	___

FERO	___

VELO	___

COMPLETE AS FRASES COM AS PALAVRAS DO QUADRO.

RAPAZ   CARTAZ   CAPUZ   XADREZ   NOZES   APRENDIZ

JOSÉ É UM BOM \_\_\_\_\_.

ELE É \_\_\_\_\_ DE MARCENEIRO.

A PROFESSORA FEZ COM OS ALUNOS UM BELO \_\_\_\_\_.

MAMÃE FAZ TORTA DE \_\_\_\_\_.

GANHEI UM \_\_\_\_\_ DE LÃ \_\_\_\_\_.

a q u b A C S Z m X N O P C G V  
 p c c u z o g s a s u q h z s p r D A m O V P N  
 h ç h C b v H a B q A C u z m O X

LIGUE OS NOMES AOS DESENHOS.



SEIS  
 DEZ  
 NOZ  
 CRUZ  
 NARIZ  
 TRÊS  
 RAPAÇ  
 DEZESSEIS

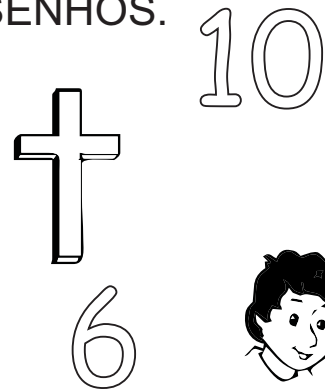

ESCREVA PALAVRAS TERMINADAS EM AZ EZ IZ OZ UZ. SIGA O MODELO.

AZ	PAZ	EZ	FEZ	IZ	RAIZ
OZ		FEROZ	UZ	CRUZ	

COMPLETE COM Z AS PALAVRAS.

DI _____	FI _____	GI _____
FE _____	FA _____	PA _____

FAÇA COMO O MODELO.

UMA CRUZ      DUAS CRUZES

UM CARTAZ - DOIS \_\_\_\_\_      UMA CRUZ - DUAS \_\_\_\_\_  
 UM NARIZ - DOIS \_\_\_\_\_      UMA RAIZ - DUAS \_\_\_\_\_  
 UM JUIZ - DOIS \_\_\_\_\_      UMA MATRIZ - DUAS \_\_\_\_\_  
 UM CAPUZ - DOIS \_\_\_\_\_      UMA VOZ - DUAS \_\_\_\_\_  
 UM RAPAÇ - DOIS \_\_\_\_\_      UMA LUZ - DUAS \_\_\_\_\_



COMPLETE AS PALAVRAS ESCRIBENDO  
AS SÍLABAS DO DESENHO.

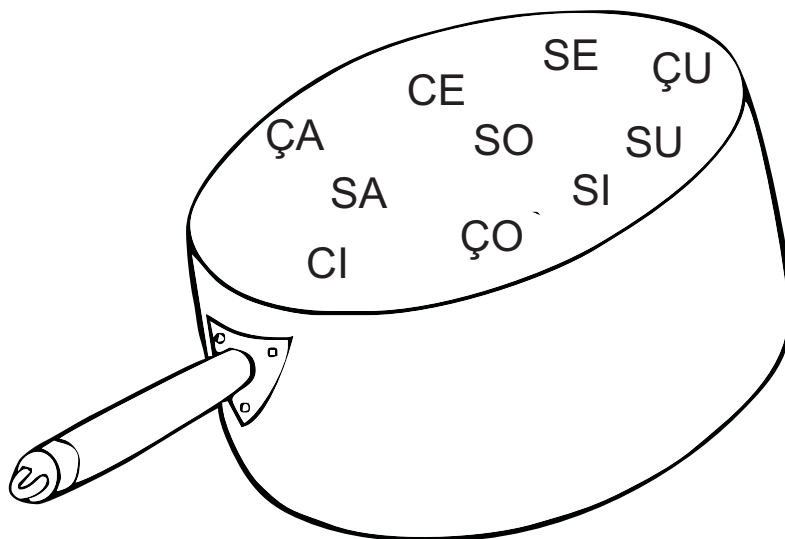

EDUCA\_\_O      \_\_BOLA      A\_\_CAR

PALHA\_\_      \_\_PÓ

OFI\_\_NA      BA\_\_A

MA\_\_      CAPA\_\_TE

CAL\_\_      PA\_\_ÊN\_\_A      LEN\_\_L

VA\_\_NA

\_\_CURI

\_\_LO      PA\_\_CA

CAL\_\_      BI\_\_CLETA

\_\_MA      \_\_NO      \_\_NEMA

\_\_DADE      LA\_\_

\_\_JO      RA\_\_O      CORA\_\_O

ENCONTRE OUTRAS PALAVRAS  
ESCONDIDAS NAS FICHAS ABAIXO.

- CAÇAROLA → CAÇA
- CEGONHA →
- CERVEJA →
- CEBOLA →
- DOCERIA →
- CERVEJADA →
- FELICIDADE →
- CIGARRA →
- BACIADA →
- CÁLICE →
- CORAÇÃO →
- BRAÇO →
- CALÇA →

COMPLETE O DIAGRAMA COM AS PALAVRAS DO QUADRO.

LAÇO	MAÇÃ	CEGONHA	CEGO
CAPACETE	CEBOLA	CEDO	CAÇA
FUMAÇA	TECIDO	CACETETE	CEBOLINHA

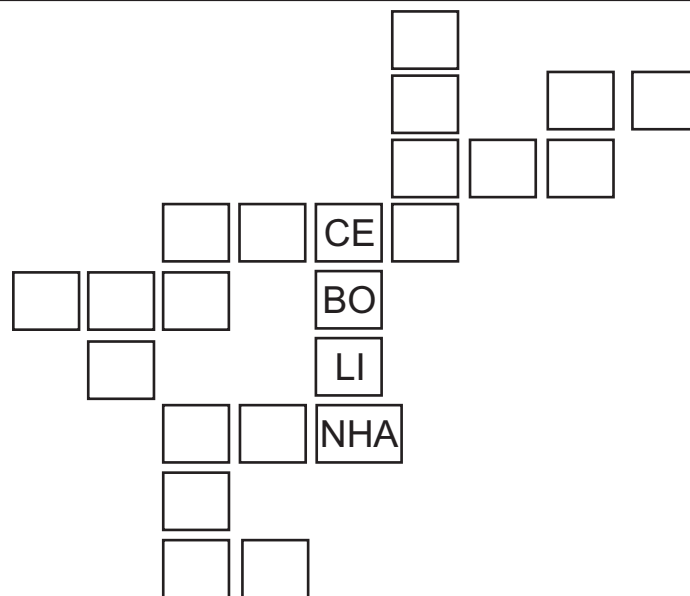

**REVISÃO.**

DESCUBRA UMA MANEIRA DE SEPARAR  
AS PALAVRAS, ABAIXO, EM DOIS GRUPOS.

LÍNGUA                      MOLEQUE                      QUEIMA  
QUIETO                      CARANGUEJO                      GUIZO  
   ÉGUA                                      QUERO  
ÁGUIA                      GUIA                                      QUERIDA  
   QUENTE                                      ÁGUA  
SANGUE                      QUEDA                      AQUELE                      QUILO

PALAVRAS COM

GU

---

---

---

---

---

---

---

---

---

---

PALAVRAS COM

QU

---

---

---

---

---

---

---

---

---

---

DESCUBRA A LETRA QUE ACRESCENTADA  
EM ALGUMAS DAS PALAVRAS ABAIXO, FORMA OUTRA  
PALAVRA COM OUTRO SIGNIFICADO, E COMPLETE O QUADRO.

BICO	BOLA	CEIA	CORO
BICHO	BOLHA		
FICA	FILA	GALO	LANCE
MINA	MARCA	ROLA	SONO
TELA	TINA	TOCA	VELA

A LETRA ACRESCENTADA É

DESCUBRA O SEGREDO  
E CONTINUE O DIAGRAMA.

OLHO

COELHINHO

VELHA

JOELHO

TOALHINHA

PALMA

FILHO

BOLHINHA

FOLHINHA

AGULHA

ABELHINHA

ORELHA

LEIA AS PALAVRAS DOS RETÂNGULOS E CIRCULE AS  
SÍLABAS QUE SÃO COMUNS EM TODAS AS PALAVRAS.  
DEPOIS, COPIE NO  A SÍLABA QUE VOCÊ CIRCULOU.

CERA - DOCE - VOCÊ - CÉU

CIRCO - POLÍCIA - TECIDO - SACI

BEIÇO - LAÇO - MOÇO - OURIÇO

AÇÚCAR - AÇUCAREIRO - AÇUDE

CALÇA - TAÇA - MOÇA - ONÇA

PERIQUITO - CAQUI - ESQUILO - QUILO

QUEIJO - QUERIDA - QUEDA - PEQUENO

AQUÁRIO - QUATRO - QUADRO - QUATI

REVISÃO **CH** **LH** **NH**.

LEIA E ESCREVA AS PALAVRAS DO QUADRO, SEPARANDO-AS DE ACORDO COM AS LETRAS INDICADAS.

**CH**

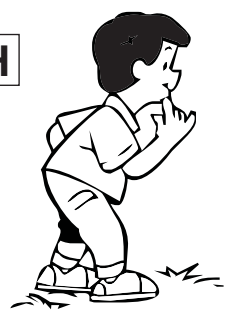

_____	_____
_____	_____
_____	_____
_____	_____

**LH**

_____	_____
_____	_____
_____	_____
_____	_____

**NH**

_____	_____
_____	_____
_____	_____
_____	_____

ARANHA	CHEIRO	FILHOTE	MILHO
PAMONHA	MANHÃ	VERMELHO	CHUMBO
FILHO	CHIADO	BOLINHO	COELHINHO
BILHETE	COMPANHIA	BOLHA	CHITA
CAMINHÃO	CHAVE	MINHOCA	BICHO
BANHO	VELHICE	GANHA	CHOCO

REVISÃO.

VAMOS VER SE VOCÊ APRENDEU?  
RECORTE AS FICHAS E COLE  
CORRETAMENTE NO QUADRO.

	CH	NH	LH
A			
O			
EI			
GA			
BO			
FI			
ÃO			
U			
IA			
MURCHA	PUNHA	CANHÃO	FILHO
TACHO	BICHÃO	GANHO	GALHÃO
ACHAR	BOCHA	GANHEI	GALHO
GANHA	FININHA	ALHO	FILHINHA
BOLINHO	ARANHA	FICHINHA	ORELHA
CHEIO	GANCHO	MILHEIRO	BOLHA
BULHA	GANHARIA	MALHARIA	ACHARIA



DESCUBRA A FAMÍLIA SILÁBICA (EM ESTUDO) E LEVE O PALHAÇO ATÉ O CIRCO, PINTANDO AS FICHAS DESSAS PALAVRAS.



PALHAÇO

MOÇA

GALHO

CEREJA

CHUVA

CHUVISCO

JOELHO

DOCE

MILHO

COELHO

FILHINHO

QUILO

PALHA

QUEIJO

ORELHUDO

ILHA

UNHA

AGULHA

PINGÜIM

ÁGUA

ORELHÃO

TRANQUÍLO

OVELHA

CHAPÉU

CALHA

TELHADO

CENOURA

BILHETE

GARGALHADA

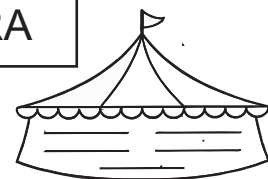









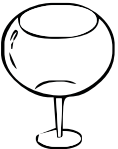

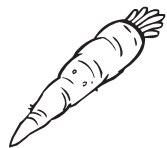
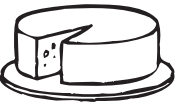
FICHAS PARA BINGO.



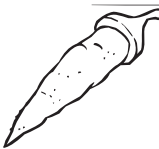









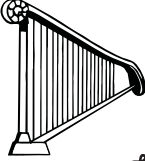
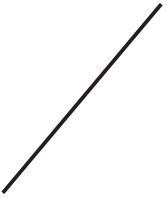

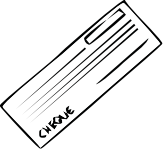
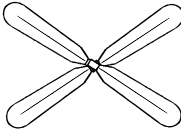
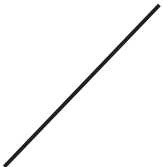



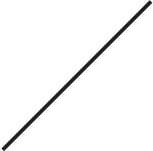

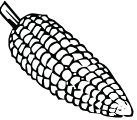
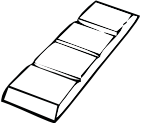
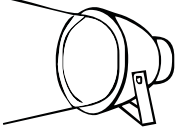
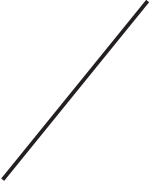

A	ÇA	QUA		GUA
E	CE	QUE	GE	GUE
I	CI	QUI	GI	GUI
O	ÇO	QUO		
U	ÇU			
ÃO	ÇÃO			
A	HA	CHA	LHA	NHA
E	HE	CHE	LHE	NHE
I	HI	CHI	LHI	NHI
O	HO	CHO	LHO	NHO
U	HU	CHU	LHU	NHU
ÃO	HÃO	CHÃO	LHÃO	NHÃO

# SILABÁRIO

<p>ça      çã</p>  <p>ÇA      Çã</p>	<p>qua      quã</p>  <p>QUA      Quã</p>	<p>/</p>	<p>gua      guã</p>  <p>GUA      Guã</p>	<p>/</p>
<p>ce      cê</p>  <p>CE      Cê</p>	<p>que      quê</p>  <p>QUE      Quê</p>	<p>ge      gê</p>  <p>GE      Gê</p>	<p>gue      guê</p>  <p>GUE      Guê</p>	<p>/</p>
<p>ci      cî</p>  <p>CI      Cî</p>	<p>qui      quî</p>  <p>QUI      Quî</p>	<p>gi      gî</p>  <p>GI      Gî</p>	<p>gui      guî</p>  <p>GUI      Guî</p>	<p>/</p>
<p>ço      çô</p>  <p>ÇO      Çô</p>	<p>quo      quô</p> <p>QUO      Quô</p>	<p>/</p>	<p>/</p>	<p>/</p>
<p>çu      çû</p>  <p>ÇU      Çû</p>	<p>/</p>	<p>/</p>	<p>/</p>	<p>/</p>
<p>/</p>	<p>/</p>	<p>/</p>	<p>/</p>	<p>/</p>

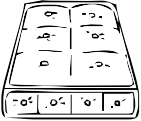
# SILABÁRIO

<p>nha nha</p>  <p>NHA Nha</p>	<p>lha lha</p>  <p>LHA Lha</p>	<p>cha cha</p>  <p>CHA Cha</p>	<p>ha ha</p>  <p>HA Ha</p>	
<p>nhe neh</p>  <p>NHE Nhe</p>	<p>lhe lhe</p>  <p>LHE Lhe</p>	<p>che che</p>  <p>CHE Che</p>	<p>he he</p>  <p>HE He</p>	
<p>nhi nhi</p>  <p>NHI Nhi</p>	<p>lhi lhi</p>  <p>LHI Lhi</p>	<p>chi chi</p>  <p>CHI Chi</p>	<p>hi hi</p>  <p>HI Hi</p>	
<p>nho nho</p>  <p>NHO Nho</p>	<p>lho lho</p>  <p>LHO Lho</p>	<p>cho cho</p>  <p>CHO Cho</p>	<p>ho ho</p>  <p>HO Ho</p>	
<p>nhu nhu</p>  <p>NHU Nhu</p>	<p>lhu lhu</p>  <p>LHU Lhu</p>	<p>chu chu</p>  <p>CHU Chu</p>	<p>hu hu</p>  <p>HU Hu</p>	
<p>nhão nhão</p>  <p>NHÃO</p>	<p>lhão lhão</p>  <p>LHÃO</p>	<p>chão chão</p>  <p>CHÃO</p>	